

Ground-Based Analogs for Human Spaceflight Research



Ronita L. Cromwell, Ph.D.
Universities Space Research Association
Flight Analogs Project Scientist
NASA Johnson Space Center

What is an analog?

○ Analog:

- an object, concept or situation which in some way resembles a different situation

○ Spaceflight analogs as used for human research:

- Create a situation that produces affects on the human body similar to those experienced in spaceflight
 - Physiological
 - Cognitive/behavioral

Why Use Ground-based Analogs for Human Spaceflight Research?

Why Use Ground-based Analogs for Human Spaceflight Research?

- Not all experiments can be done in flight
 - Resources are limited (time, dollars)
 - Take significantly longer to complete studies (multiple flights needed to achieve required n)

Why Use Ground-based Analogs for Human Spaceflight Research?

- Not all experiments can be done in flight
 - Resources are limited (time, dollars)
 - Take significantly longer to complete studies (multiple flights needed to achieve required n)
- Allows for selection of best candidate countermeasures before using them in flight

Why Use Ground-based Analogs for Human Spaceflight Research?

- Not all experiments can be done in flight
 - Resources are limited (time, dollars)
 - Take significantly longer to complete studies (multiple flights needed to achieve required n)
- Allows for selection of best candidate countermeasures before using them in flight
- Saves time and money as studies can be completed more quickly and less expensively on the ground.

Flight Analogs Project

- ◉ Coordinates science in ground-based analogs that support NASA investigations
 - NEEMO
 - Haughton-Mars
 - Antarctica
 - Flight Analogs Research Unit

NEEMO

- NASA Extreme Environment Mission Operations

- Located 3.5 miles off of Key Largo, FL

- Facility Operations:

- National Oceanic & Atmospheric Administration (NOAA)
- National Undersea Research Center at University of North Carolina, Wilmington (NURC)



NEEMO

○ Aquarius

- Underwater habitat - an environment similar to living in space
- Operating depth 47 feet
- 11 cubic meters living/lab space, similar to Destiny module of the ISS



○ Application

- Isolation/confinement
- telemedicine
- Extravehicular activities
- simulations of partial gravity

○ For more information

- http://www.nasa.gov/mission_pages/NEEMO/index.html
- <http://www.uncw.edu/aquarius>

NEEMO Investigations

○ Nutritional

- Smith SM, Davis-Street JE, Fesperman JV, Smith MD, Rice BL, Zwart SR. **Nutritional assessment during a 14-d saturation dive: the NASA Extreme Environment Mission Operations V project** *J Nutr* 134:1765-1771, 2004.
- Zwart SR, Kala G, Smith SM. **Body iron stores and oxidative damage increased after a 10- to 12-day undersea dive in humans.** *J Nutr* 139:90-95, 2009.

○ Immune

- Crucian B, Stowe R, Mehta S, Quiriarte H, Yetman D, Pierson D, Sams C. **Immune Function Changes During a Spaceflight-analog 12-day Undersea Mission.** HRP IWG, 2008.

○ Behavioral

- PI: D Dinges. **Vigilance, Stress and Sleep/Wake Measurements - NEEMO 13**
- PI: N Kanas. **Effects of High vs Low Autonomy on Space Crewmember Performance -NEEMO 13**

○ EVA

- PI: M. Gernhardt. **Advanced Extravehicular Activity (EVA) Exploration Activities Study to Assess Human Performance Responses in Partial Gravity Environments**

Haughton-Mars

○ Location

- Site of the Haughton meteorite impact crater
- Devon Island in the Canadian high arctic

○ Facility Operations

- Mars Institute
- SETI Institute (Search for Extraterrestrial Intelligence)



Haughton-Mars

- Haughton-Mars Project

- International, interdisciplinary field research project
- Rocky, polar desert setting provides insights into the evolution of Mars
- Terrestrial analog for Mars

- Application

- Human performance
 - physical
 - behavioral
- Extravehicular activity systems
- Human factors

- For more information

- <http://www.marsonearth.org>



Haughton-Mars Investigations

● Immune

- Crucian B, Lee P, Stowe R, Jones J, Effenhauser R, Widen R, Sams C. **Immune system changes during simulated planetary exploration on Devon Island, high arctic.** BMC Immunol 8:7, 2007.

● Med Ops

- Scheuring RA, Jones JA, Lee P, Comtois JM, Chappell S, Rafiq A, Braham S, Hodgson E, Sullivan P, Wilkinson N, Bach D, Torney S. **An Evidence-based approach to Developing a Management Strategy for Medical Contingencies on the Lunar Surface.** 16th Annual Humans In Space 2007, Beijing, China
- Chappell SP, Scheuring RA, Jones J A, Lee P, Comtois J M, Chase T, Gernhardt M, Wilkinson N. **Equipment and Methods for Medical Evacuation of an Injured Crewmember.** AsMA Annual Conference, 2007, New Orleans, LA

● Behavioral

- PI: D F Dinges. **Vigilance, Stress and Sleep/Wake Measures in HMP – 2008 – A Simulated Lunar Environment.**
- PI: N Kanas. **Effects of High vs. Low Autonomy on Space Crewmember Performance.**
- PI: L Schmidt. **Measures of Team Cohesion, Team Dynamics, and Leadership in a Simulated Lunar Environment.**

Antarctica

- 64 stations operated by 20 countries
- United States Antarctic Program
 - National Science Foundation, Office of Polar Programs
- 3 year-round research stations
 - Palmer Station
 - Amundsen-Scott South Pole Station
 - McMurdo station
 - Main US station
 - Located on Ross Island

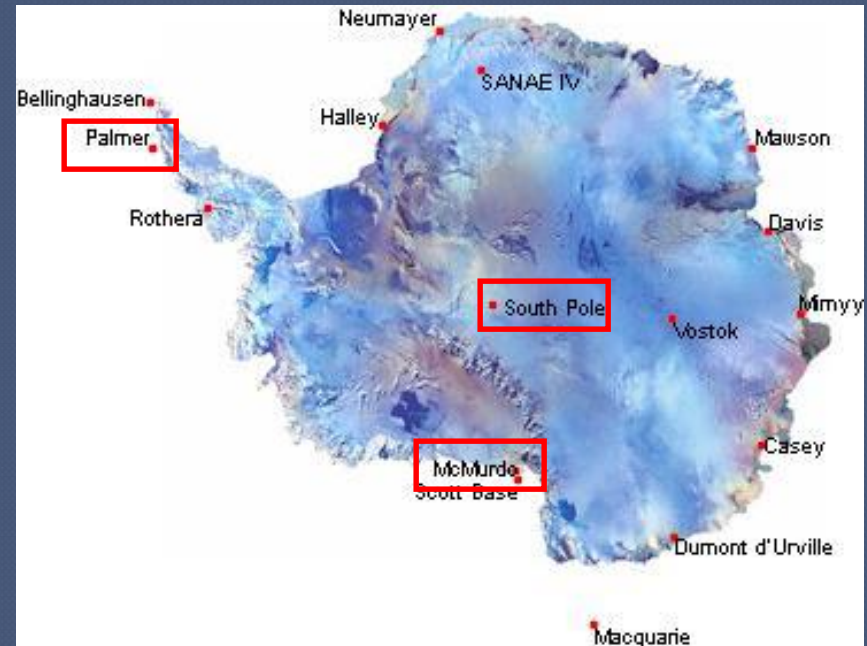

Antarctica

○ Antarctic

environment

- Climate, terrain, temperature, isolation and stress parallels that of long-duration

- For more information on space missions

http://www.nsf.gov/od/opp/antarct/treaty/opp08001/bigprint0708/bigprint0708_toc.jsp

<http://www.antarcticconnection.com/antarctic/stations/index.shtml>

○ Application

- Isolation/confinement
- physiological stress
- disrupted circadian rhythms
- telemedicine



Antarctica Investigations

○ Nutritional Studies

- Smith SM, Gardner KK, Locke J, Zwart SR. **Vitamin D supplementation during Antarctic winter**. *Am J Clin Nutr* (in press).

○ Immune

- Choukèr A, Baatout S, Campolongo P, Crucian B, Duchamp C, Gunga H, Kaufmann I, Kreth S, Pierson D, Praun S, Raccurt M, Sams C, Schachtner T, Schelling G, Thiel M. **Consequences of longterm-Confinement and Hypobaric HypOxia on Immunity in the Antarctic Concordia Environment** (*CHOICE* – Study)

Flight Analogs Research Unit (FARU)

○ Flight Analogs Research Unit

- Located at University of Texas Medical Branch in Galveston, TX
- Bed rest facility for NASA studies

○ Facility Operations:

- NASA funded through the NIH to the Institute for Translational Sciences - Clinical Research Center at UTMB



History of Bed Rest as a Spaceflight Analog

- 1961: human spaceflight begins and bed rest is used as a ground-based analog of inactivity.
- Early 1970s: cosmonauts return from longer duration missions
 - difficulty sleeping due to sensation of slipping off the end of the bed
 - Foot of the bed was raised to compensate, then gradually lowered to horizontal

History of Bed Rest as a Flight Analog

- Soviets tested a variety of tilt angles
 - 6° of head down tilt (HDT) optimized comfort and provided sufficient magnitude of physiological responses.
- HDT position provides the added benefit of studying fluid shifts that produce cardiovascular changes.
- 6° HDT bed rest is an accepted model for studying physiological affects of spaceflight on bone, muscle and cardiovascular systems.

Head Down Tilt Bed Rest

- serves as a model for studying the physiological changes that occur during spaceflight under controlled conditions;
- provides a platform for comparison between bed rest and spaceflight;
- provides a mechanism for testing countermeasures prior to being used in flight.



NASA Flight Analogs Research Unit



UTMB



**Children's
Hospital**



**Flight Analogs
Research Unit**

Standard Conditions

- 6° HDT bed rest
- Room Temperature: 70-74°
- Study duration
 - 13-15 days pre-bed rest
 - 30 or 60 days in bed
 - 14 days recovery
- Sleep/Wake cycle
 - Wake at 0600 hrs
 - Lights out at 2200 hrs

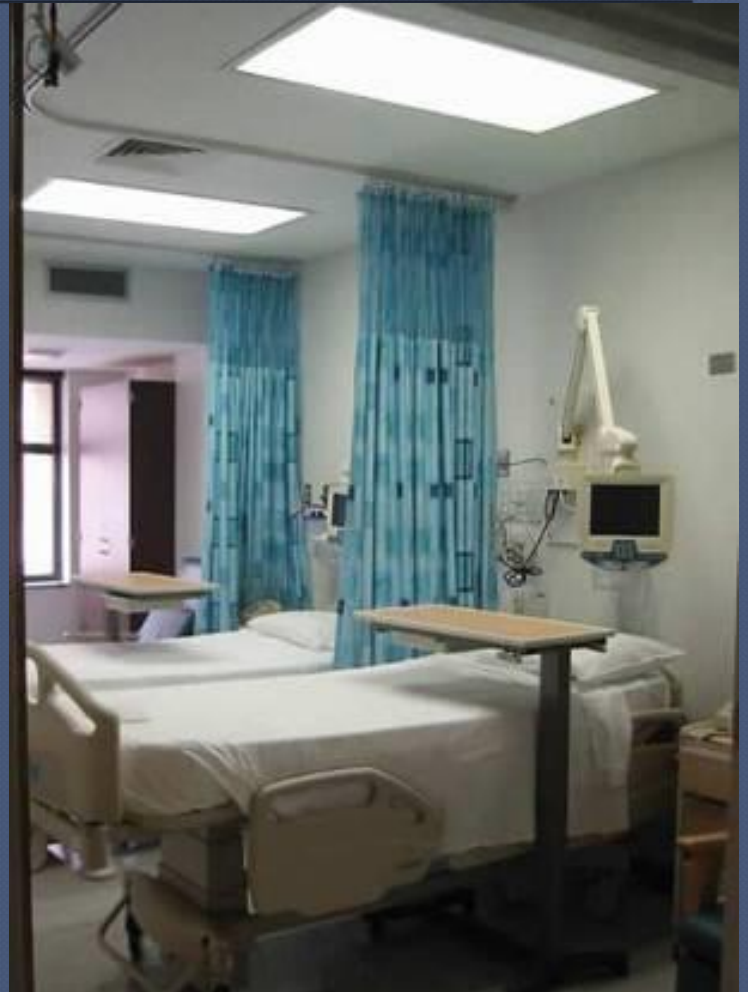

Standard Conditions

- Monitored 24 hrs/day
 - Subject monitors
 - cameras
- Daily Vital signs
 - Blood pressure
 - Heart rate
 - Body temperature
 - Respiratory rate
 - Body weight (bed scale)
- Fluid intake and output is measured
- Psychological support provided



Standard Conditions

- Stretching twice each day
- Physiotherapy (massage therapy)
 - every other day during bed rest
 - daily for 1st week post bed rest
- No exercise permitted



Standard Diet

- Isocaloric diet based on NASA spaceflight nutritional requirements
- Caloric intake 35.7 kcal/kg body weight (2500 calories/70 kg subject)
- Fluid intake 28.5 ml/kg body weight (2000 ml/70 kg subject)
- Carbohydrate:Fat:Protein ratio 55:30:15
- No caffeine, cocoa, chocolate, tea or herbal beverages
- All food must be consumed
- Caloric intake adjusted to weight within 5%



Isocaloric Diet Body Mass Maintenance

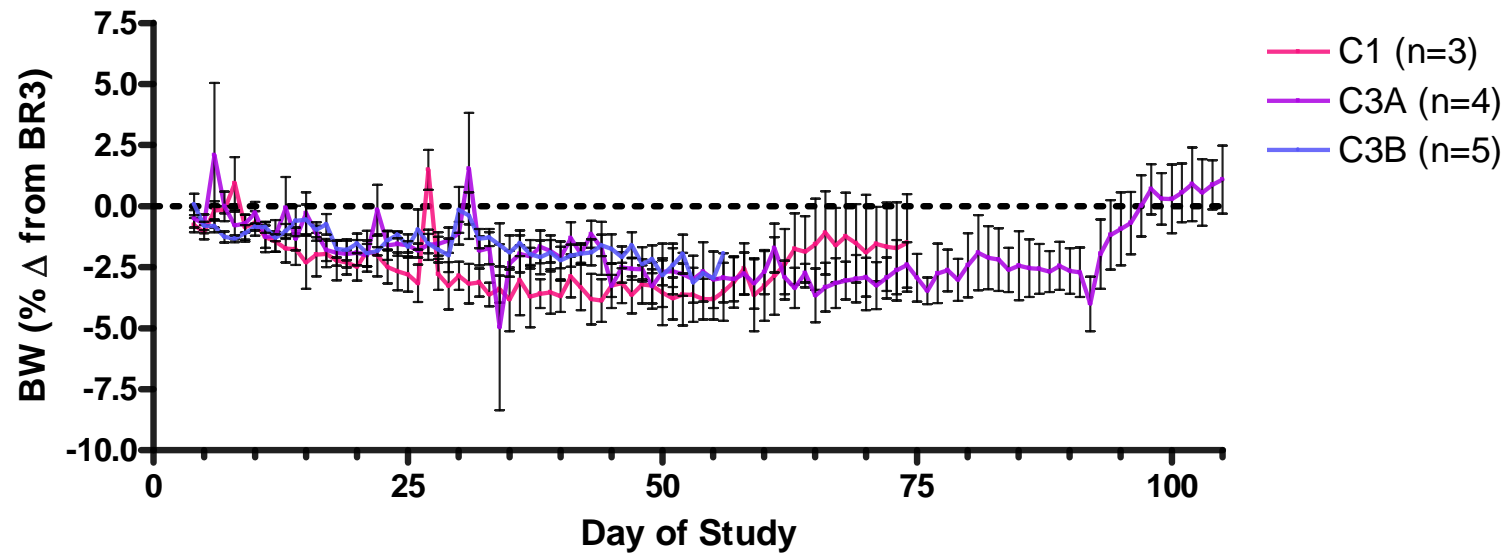

Purpose of Standard Measures

- Characterize human responses to head down tilt bed rest.
- Provide a basis for comparison between bed rest and spaceflight
- Provide a mechanism to assess candidate countermeasures in a multidisciplinary manner to determine outcomes on non-targeted systems.

Standard Measures

- **Clinical Laboratory Assessment**

- Blood and urine studies to monitor subject health

- **Immune Status**

- General immune status
- Viral specific immunity
- Latent Viral Reactivation
- Physiological stress

- **Nutrition**

- Nutritional analysis
- Markers of bone resorption and bone formation
- Circulating bone and calcium regulatory factors
- Antioxidants and oxidative damage

Standard Measures

○ Bone Assessment

- Dual Energy X-Ray Absorptiometry (DXA) – Bone Density



Standard Measures

○ Physical Fitness

- Isokinetic Testing – muscle strength/endurance
- Cycle Ergometry – maximum aerobic capacity
- Functional Fitness – strength, endurance, flexibility



Standard Measures

- **Functional Neurological Assessment**
 - Posturography testing – standing posture
 - Stretch Reflex – monosynaptic



Standard Measures

- **Cardiovascular**
 - Operational Tilt Test for orthostatic tolerance
 - Plasma volume assessment
 - Echocardiography to assess cardiac function



ASEM Special Supplement

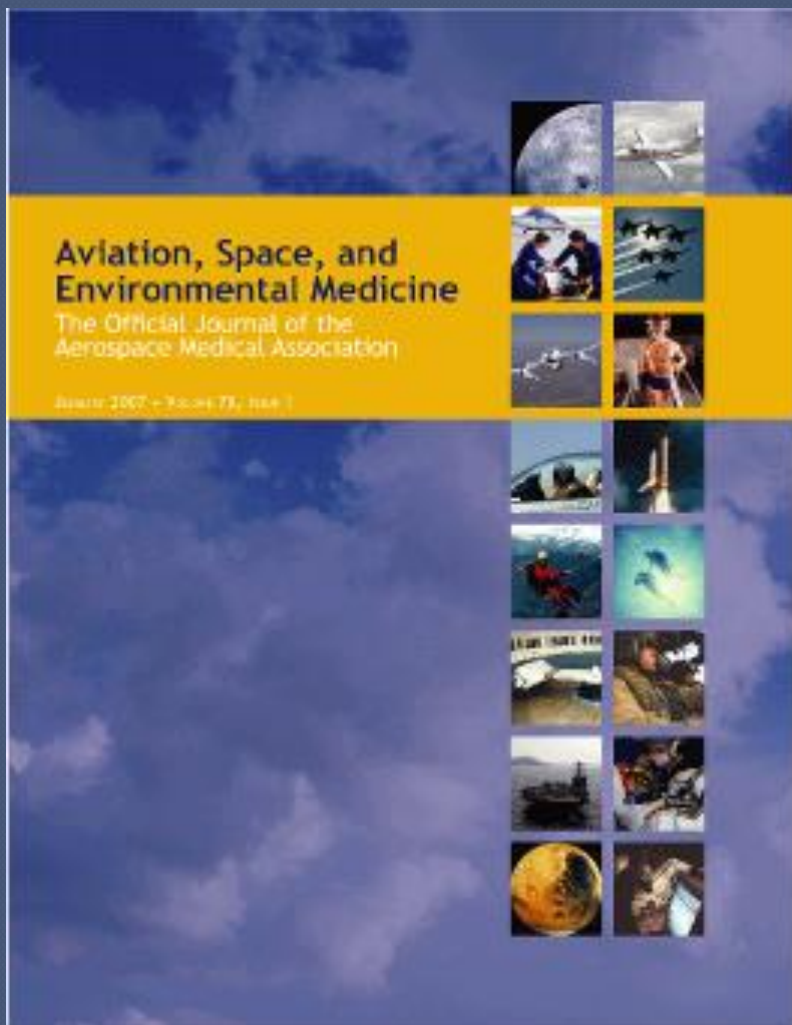

● The NASA Flight Analog Project: Head-Down Bed Rest Studies; Vol.80 (5), May 2009

- Long-duration head-down bed rest: Project overview, vital signs, and fluid balance
- Dietary support of long duration bed rest.
- Nutritional status assessment before, during, and after 60 to 90 days of bed rest
- Skeletal effects of long-duration head-down bed rest
- Cardiovascular adaptations to long duration head-down tilt bed rest.
- Immune status, latent viral reactivation and stress during bed rest as a spaceflight analog
- Postural reflexes, balance control, and functional mobility with long-duration head-down bed rest
- Behavioral and psychological issues in long duration head-down bed rest
- Cognitive functioning in long duration head-down bed rest

Results from Standard Measures

○ Bone

○ Consistent with spaceflight:

- bone loss during bed rest is most pronounced in weight bearing regions: hip, pelvis and heel.
- average monthly bone loss is 1-1.5% for the hip and pelvis
- greatest rate of bone loss occurs in the trochanter
- Bone biomarkers show elevated resorption with no changes in formation

Changes in BMD after Bed Rest and Space Flight

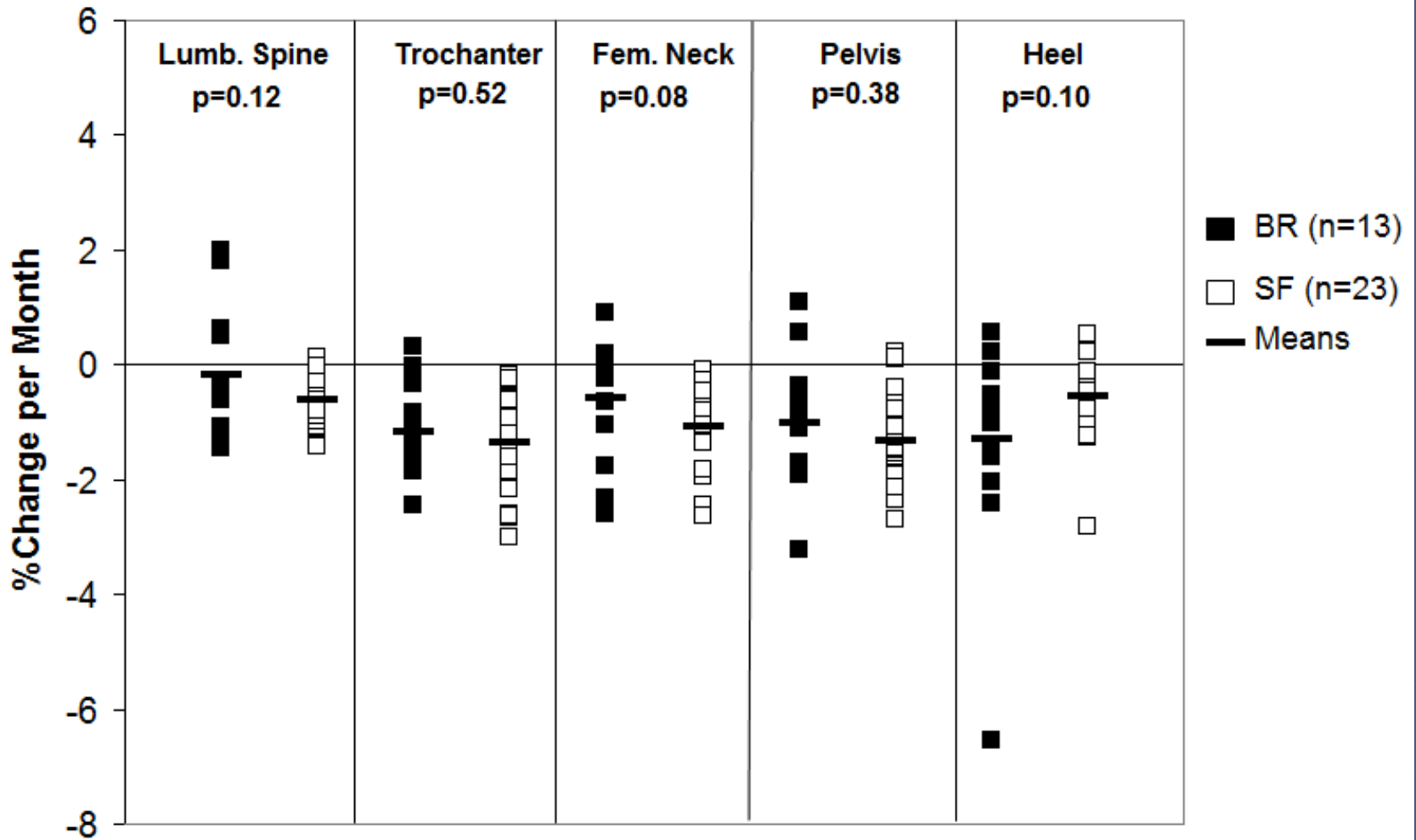

Results from Standard Measures

○ Cardiovascular

- Similar to spaceflight, plasma volume losses up to 15% occur early in bed rest (day 7).
- Orthostatic tolerance is reduced in bed rest, showing trends similar to spaceflight.

Plasma Volume Losses during Bed Rest

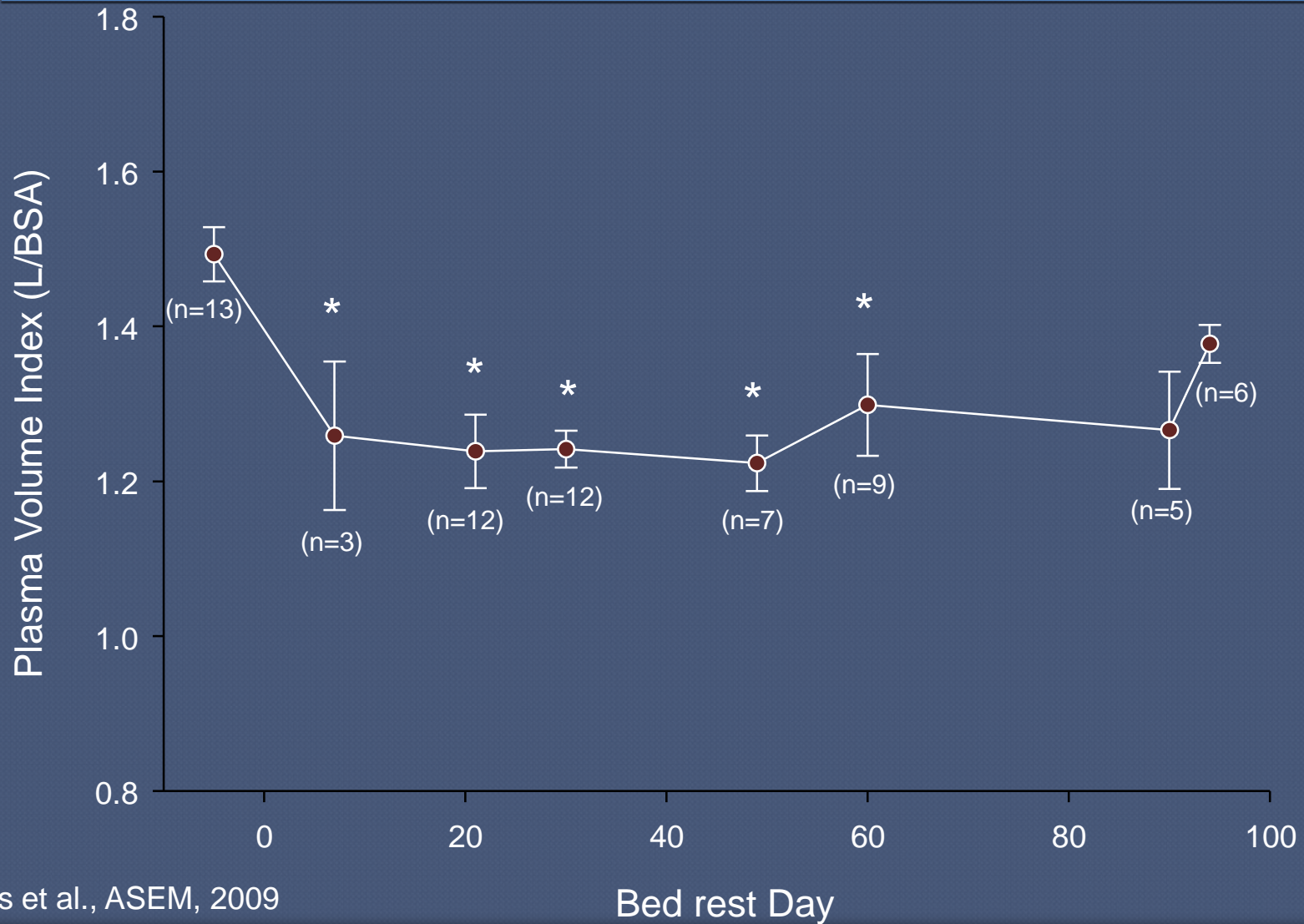

Muscle

- Similar to spaceflight, long duration bed rest produces losses in muscle strength.
- Strength loss is more pronounced in the extensor (antigravity) muscles.

Muscle Strength

Space Flight

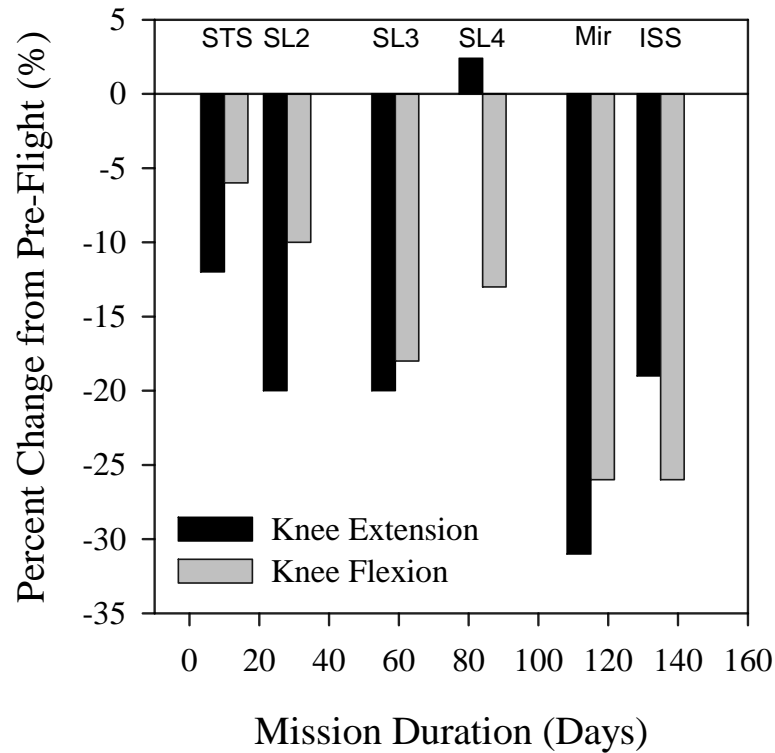

Bed Rest

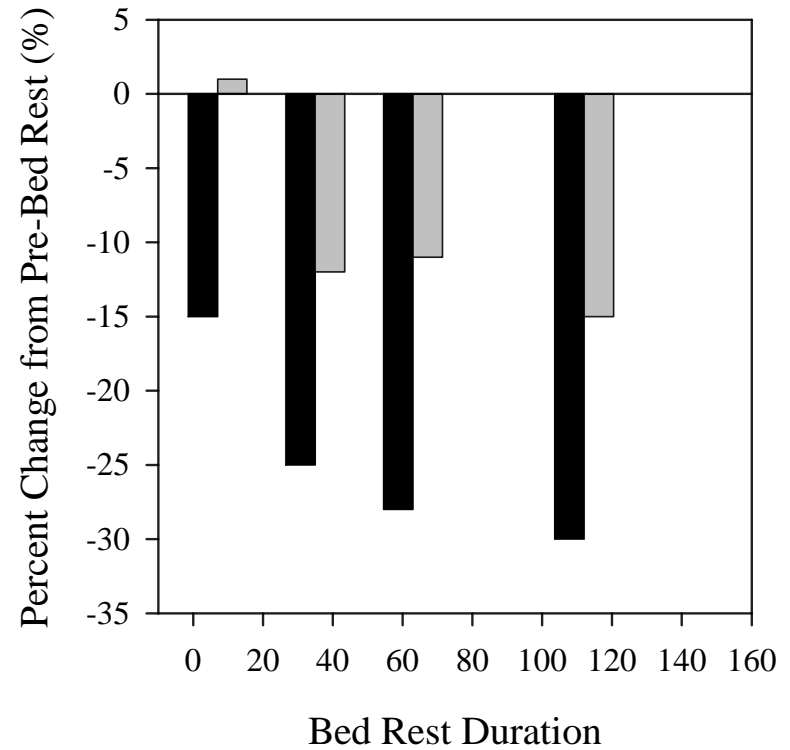

Current Studies in HDT Bed Rest

30-day Studies

- Rapid Measurements of bone loss using Tracer-less Calcium Isotope Analysis of Blood and Urine
 - A. Anbar, Arizona State University
 - Development of methods for early detection of changes in bone mineral balance through measures of calcium isotope composition in blood and urine
- Validation of Near Infrared Spectroscopy (NIRS) Measures following Bed Rest
 - B. Soller, University Massachusetts
 - Validation of NIRS device as a non-invasive mechanism to continuously measure VO_2 during exercise.



Current Studies in HDT Bed Rest

30-day Studies

- Methods for the Assessment of Gastrointestinal (GI) Physiology and Function in a Reduced Gravity Analog
 - L. Putcha, NASA
 - Pharmacokinetics assessment of GI function using SmartPill[®] technology to measure pH, temperature and pressure
- Non-invasive Device for Measuring Core Temperature during Maximal Exercise
 - H. Gunga, ESA
 - Non-invasive device for estimating core temperature during maximal exercise



Current Studies in HDT Bed Rest

84-day Study

- A Quantitative Test of On-Orbit Exercise Countermeasures for Bone Demineralization Using a Bed Rest Analog
 - P. Cavanagh, University of Washington, NASA, ECP
 - Examination of an individualized, intermittent load replacement to protect against losses in bone mineral density, bone quality and muscle atrophy



60-day Study

- Gender Differences in Bed Rest: Autonomic and Neuroendocrine Changes and Vascular Response in Lower and Upper Extremities
 - S. Platts, NASA
 - Examination of mechanisms controlling orthostatic tolerance to determine differences between men and women

Lunar Bed Rest Model

- Previous missions to the moon have not returned enough information to fully understand how the human body performs in lunar gravity.
- Similar to the head-down tilt bed rest analog, a head-up tilt lunar bed rest model is being developed.

1/6 g Bed Rest Model

$$F = W \sin (9.5\text{deg}) \\ = 0.165 W$$

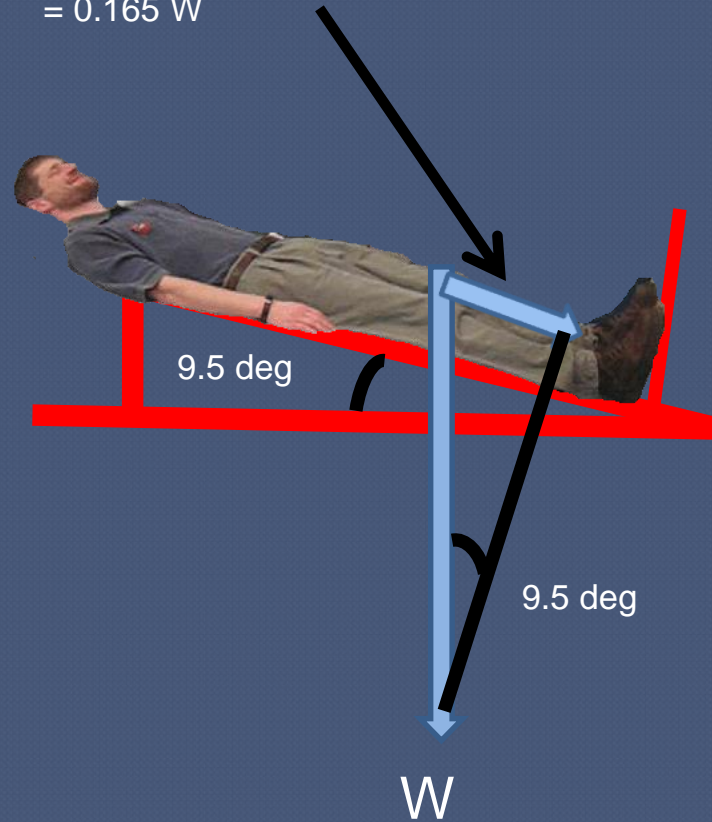

Angle required to achieve lunar gravity loads along the long axis (z axis) of the body.

Lunar Gravity Simulator Bed

- ◉ 9.5° tilt
- ◉ Linear bearings
 - allow sled/mattress to travel on rails
- ◉ Counterweight system
 - balance the mattress weight allowing subject to experience the true 1/6 g load
- ◉ Standing and seated positions permitted



Lunar Bed Rest Model

- 9.5° head up tilt and deconditioning associated with bed rest provide the stimulus to induce the physiological changes in
 - Bone
 - Muscle
- Compression stockings in combination with unweighted foot and ankle movements facilitated cardiovascular fluid shifts expected at 1/6 g
 - Digital Astronaut predicted
 - 6% plasma volume **loss** on the moon
 - 6% plasma volume **gain** in 9.5° head up tilt model
 - Combination of stockings and movement also served to prevent deep vein thromboses in bed rest.

Lunar Analog Feasibility Study (LAFS)

○ Purpose:

- To determine the feasibility of using a 9.5° head-up tilt bed rest model to simulate the effects of the 1/6 g load to the human body that exists on the lunar surface.
- Development of such an analog will allow for future studies to examine the potential for a protective effect of partial gravity on the human body, and help to guide countermeasure development for this environment.

LAFS Study Protocol

Pre-Bed Rest													9.5 ° Head Up Tilt Bed Rest						Post Bed Rest	
BR	BR	BR	BR	BR	BR	BR	BR	BR	BR	BR	BR	BR	BR	BR	BR	BR	BR	BR	BR	BR
-13	-12	-11	-10	-9	-8	-7	-6	-5	-4	-3	-2	-1	1	2	3	4	5	6	+0	+1
Diet stabilization																				
													Comfort							
PV																			PV	
													Force							

- 8 subjects, diet stabilized prior to bed rest
- 1/6 body weight verified during standing
- Comfort - visual analog scale
- Plasma volume assessed pre/post bed rest

Overall

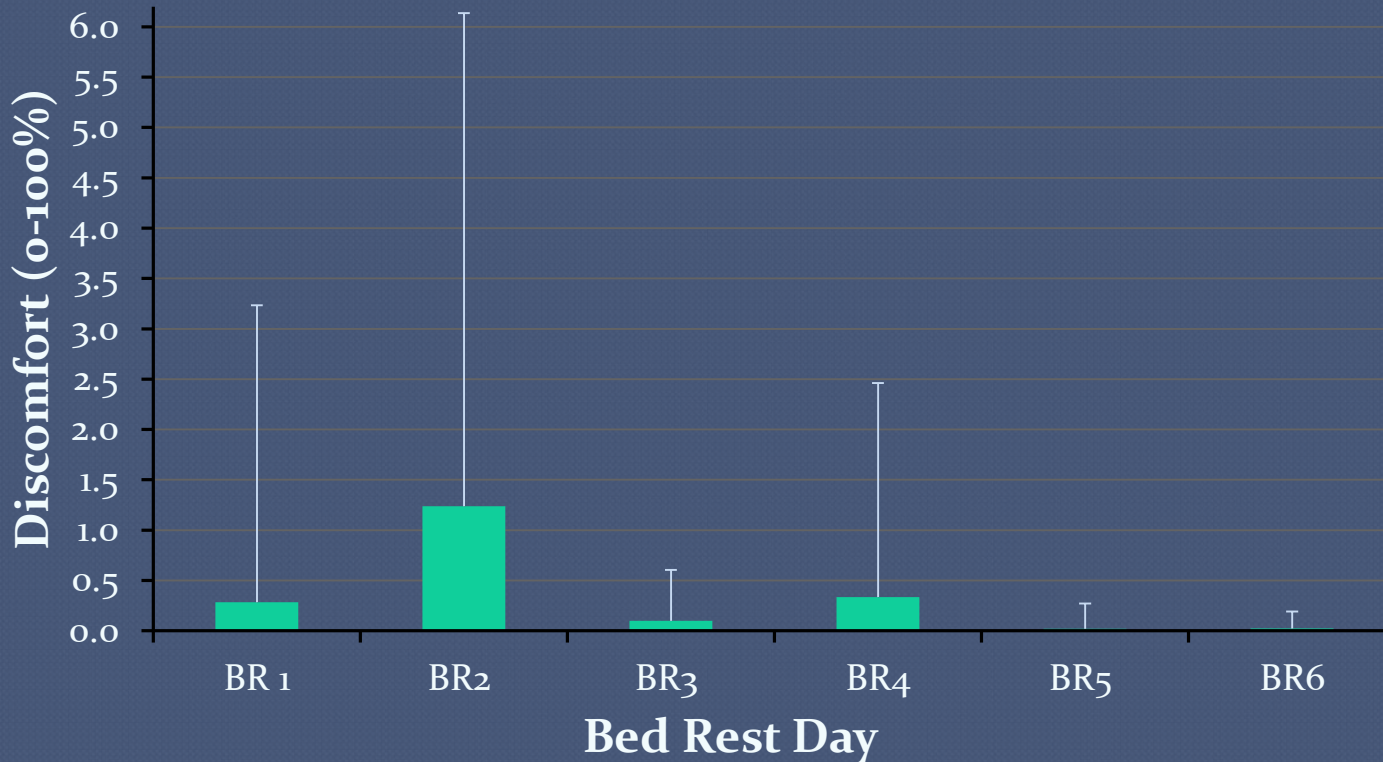

Data for Overall comfort assessment plotted against bed rest days. Data represent means and standard deviations for all subjects on each bed rest day. Level of discomfort is expressed as zero to 100%.

Plasma Volume

PVI Pre Bed Rest	PVI Post Bed Rest	% Change	95% CI
1.42 ± 0.1	1.30 ± 0.1*	-8.33 ± 6.1	-12.8 - -3.8

Notes. PVI = plasma volume index (L/m²)

* Different from pre bed rest, p = .001

Lunar Analog Bed Upgrade

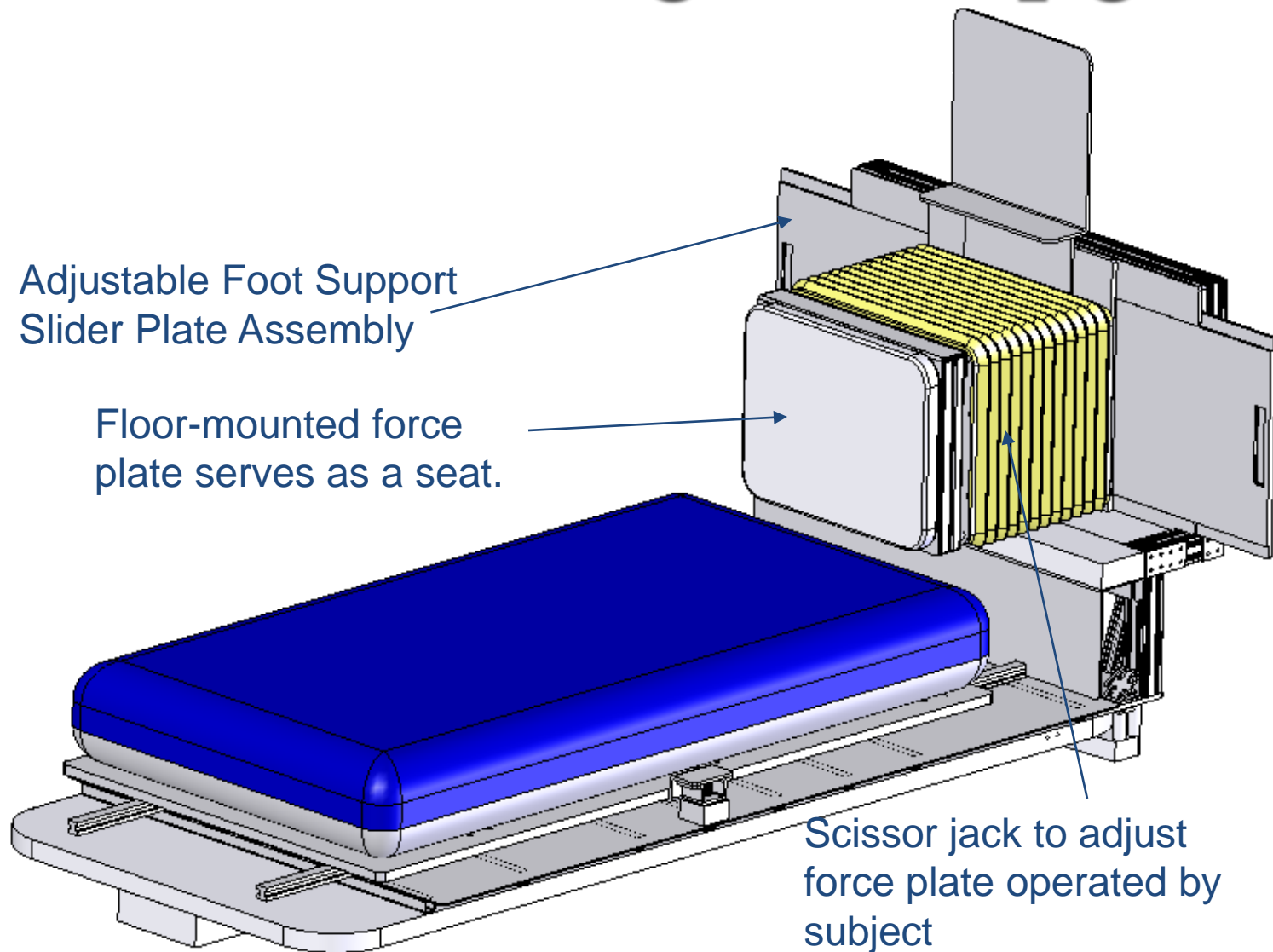



Questions?

