

Cosmology at the Microscopic Scale

B. Paul Padley
Rice University

What a Great Time to Be a Physicist

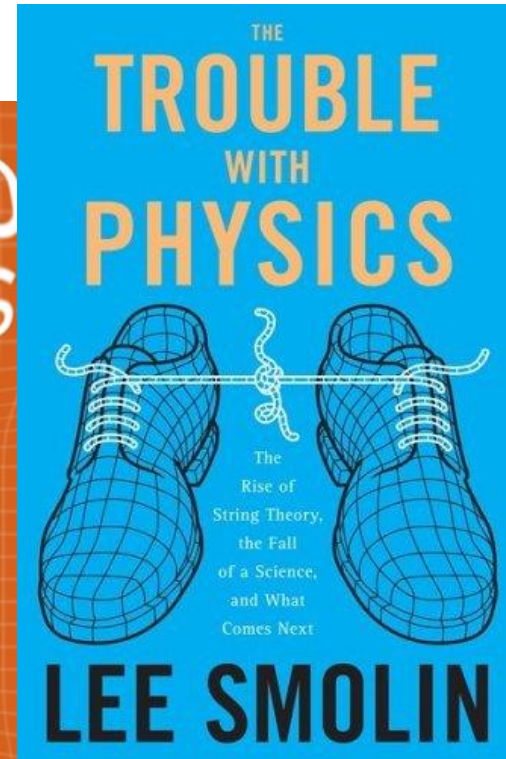
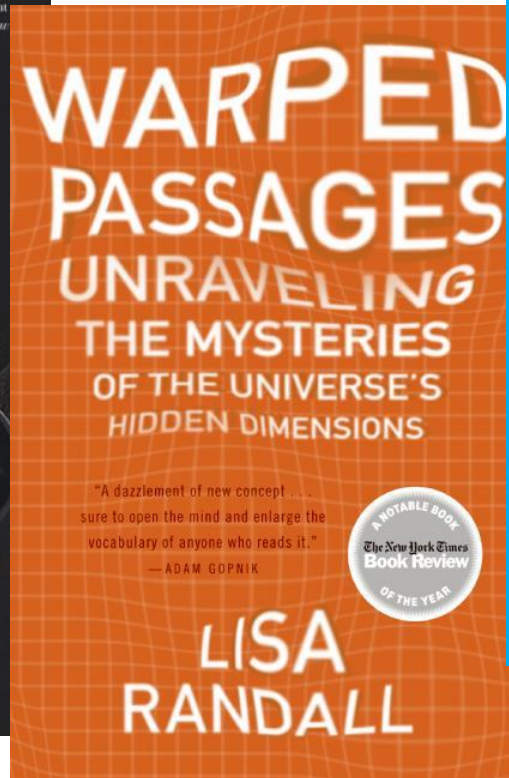
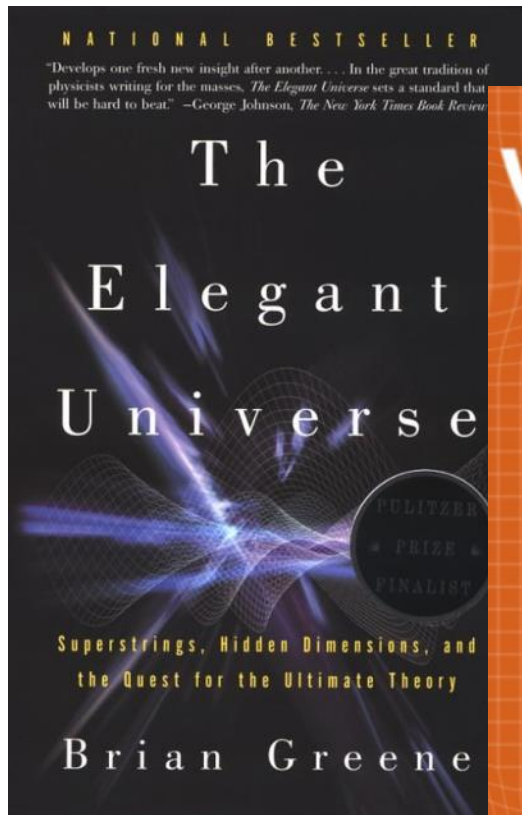

There is certainly an abundance of ideas

What a Great Time to Be an Experimentalist

- The theorists have been generating lots of fascinating ideas
- Unfortunately they have not been well constrained by experiment
- Now new experiments are about to be turned on
- We are going to find some answers
- What are the odds most (all?) of the theorists are wrong?

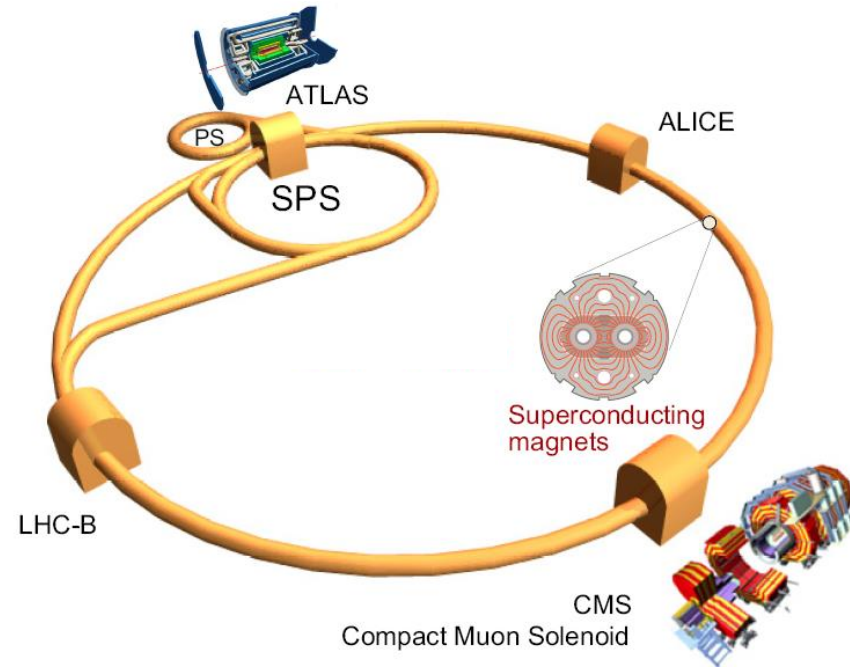

What is Cosmology?

cosmology [χοσμολογψ] (pl. cosmologies)



the science of the origin and development of the universe.

an account or theory of the origin of the universe.

www.hetemeel.com

bloed
haema
haema
haemo
haemo
ziekte
haemo
haemo
hafiz [

What has that to do with the microscopic

- At first glance, the microscopic word seems to have nothing to do with the cosmological, yet physicists who have been studying the cosmological are deeply interested in our experiment which will study the smallest scales ever examined.



OK, you all recognize Stephan Hawking, here shown visiting our experiment,

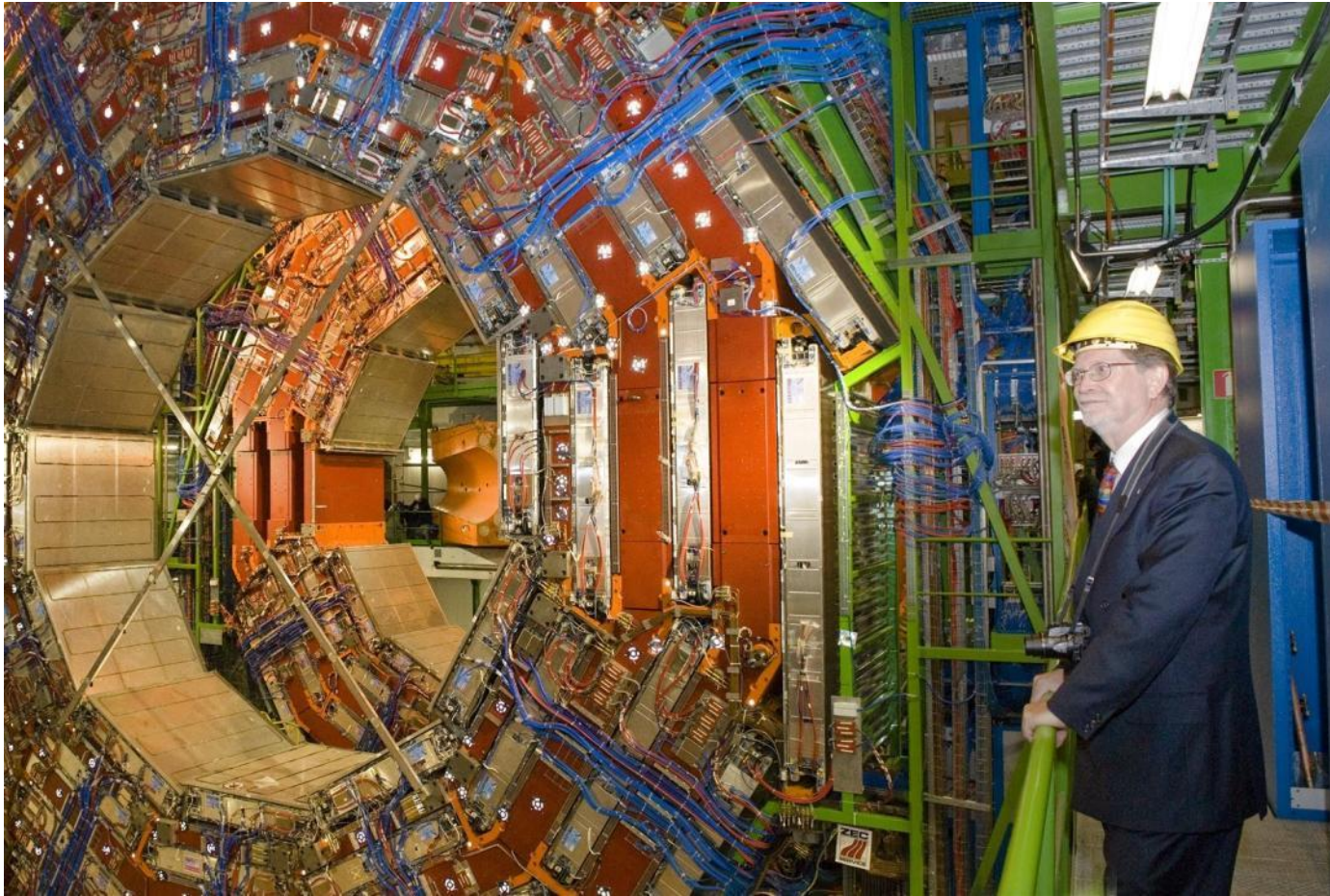

This is George Smoot who won the Nobel Prize in Physics for studying the Cosmic Microwave background

Cosmic Microwave Background

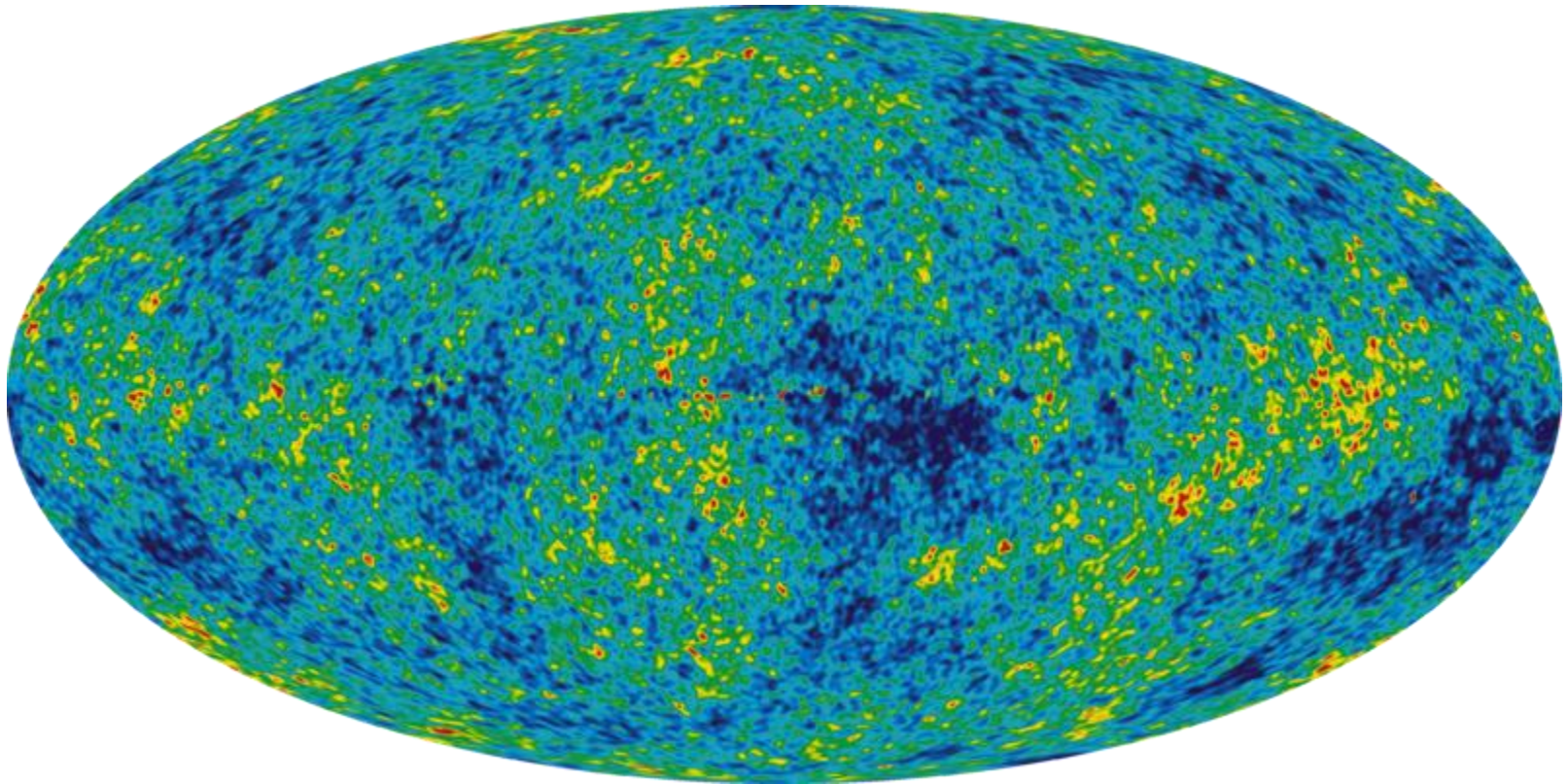

This is a picture of the universe when it was 380,000 years old
Where did those fluctuations come from?

We must understand the very small to understand the structure of the Universe.

I.e. we must understand the fundamental particles and their interactions.

There are two very
important difficulties we
face doing that

Problem 1

Mysterious Dark Stuff

- The prevailing opinion is that the most prevalent form of matter in the universe is some unidentified new form of matter, most likely a new fundamental particle.
- Evidence for this was first noticed in the 1930's
- Recently the astronomical evidence has become overwhelming



Fritz Zwicky (above) pointed out problems with Galaxy Clusters in the 30's

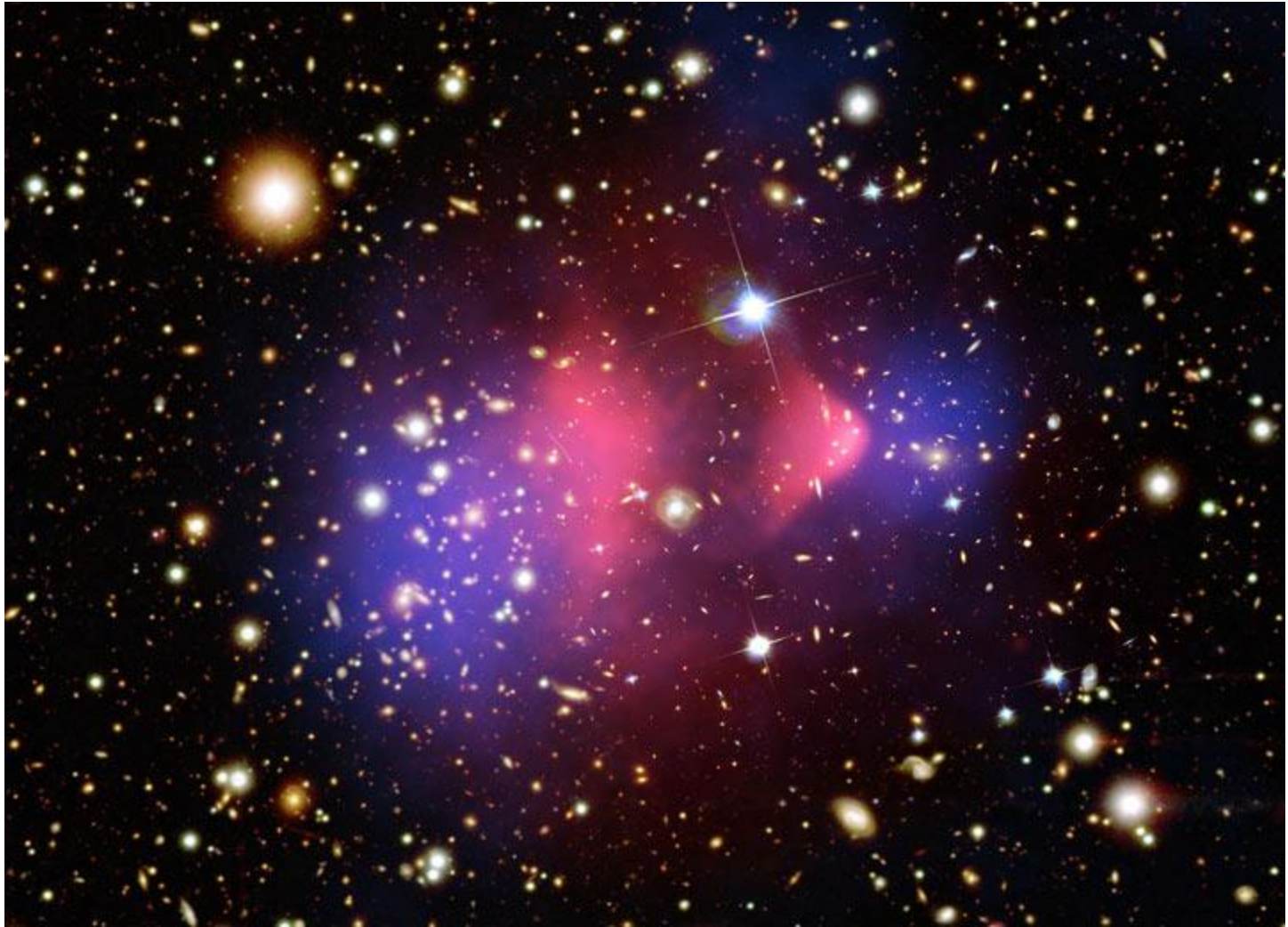

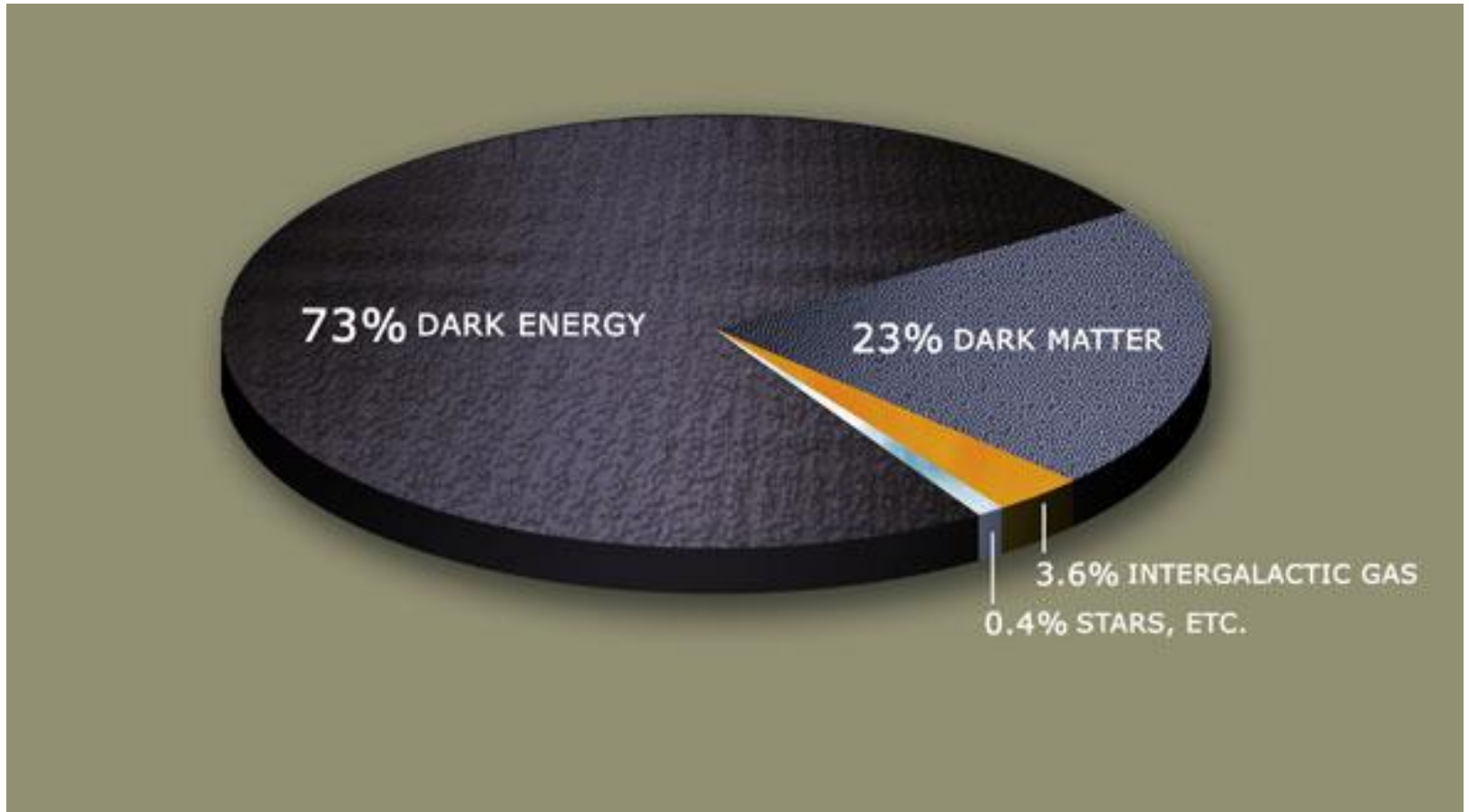

So one problem is that we don't know what the universe is made out of.

Theoretical Predictions

- There are a multitude of theories to explain what dark matter is.
- They consistently predict that dark matter particles will be produced at the LHC
- Of course we wont be able to see these particles, directly

How to look for dark matter

- In fact we have done this before
- Pauli postulated the neutrino to explain beta decay spectra in the 1930's
- A direct observation was not made until the 1950's
- (However past performance is not a guarantee of future performance, its crucial that we do the direct searches as well)

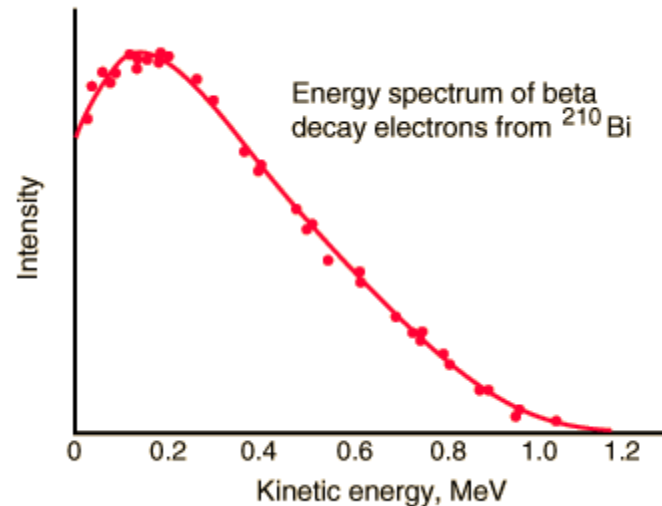

Samina Masood of UH Clear Lake is a world expert on how you calculate the details of this curve

The Key Dark Matter Signature

- Since the dark matter candidates are undetectable (or else they would not be dark) they should escape the detector undetected
- The signal is missing energy and momentum
- We sum up the momentum in the plane transverse to the beam directions and look for an imbalance (it should sum to zero)

Problem 2

Lets do an experiment

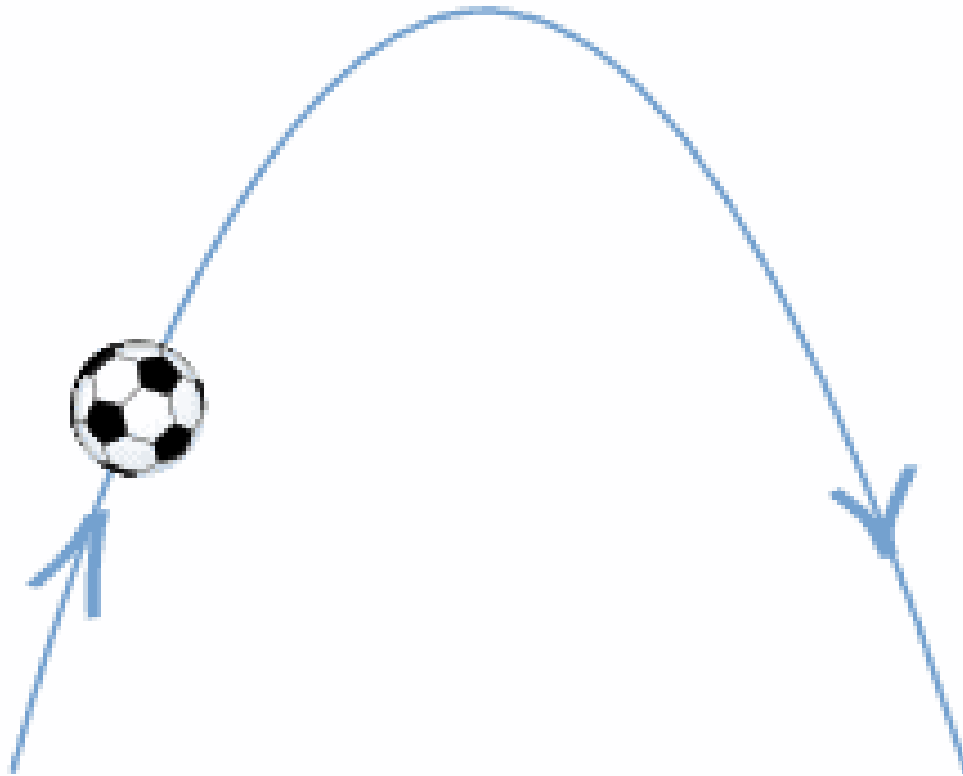

40 Order of magnitude issue!

Properties of the Interactions

The strengths of the interactions (forces) are shown relative to the strength of the electromagnetic force for two u quarks separated by the specified distances.

Property	Gravitational Interaction	Weak Interaction (Electroweak)	Electromagnetic Interaction	Strong Interaction
Acts on:	Mass – Energy	Flavor	Electric Charge	Color Charge
Particles experiencing:	All	Quarks, Leptons	Electrically Charged	Quarks, Gluons
Particles mediating:	Graviton (not yet observed)	W^+ W^- Z^0	γ	Gluons
Strength at $\left\{ \begin{array}{l} 10^{-18} \text{ m} \\ 3 \times 10^{-17} \text{ m} \end{array} \right.$	10^{-41} 10^{-41}	0.8 10^{-4}	1 1	25 60

David Garrison at UHCL is a gravitation expert

Unification of the forces?

- Gravity appears to be different from the other forces.
- We have not been able to reconcile gravity with quantum mechanics.
- Most physicists agree that this is telling us that there is something fundamental about the forces (or at least gravity) that we have not understood.

Extra Dimensions

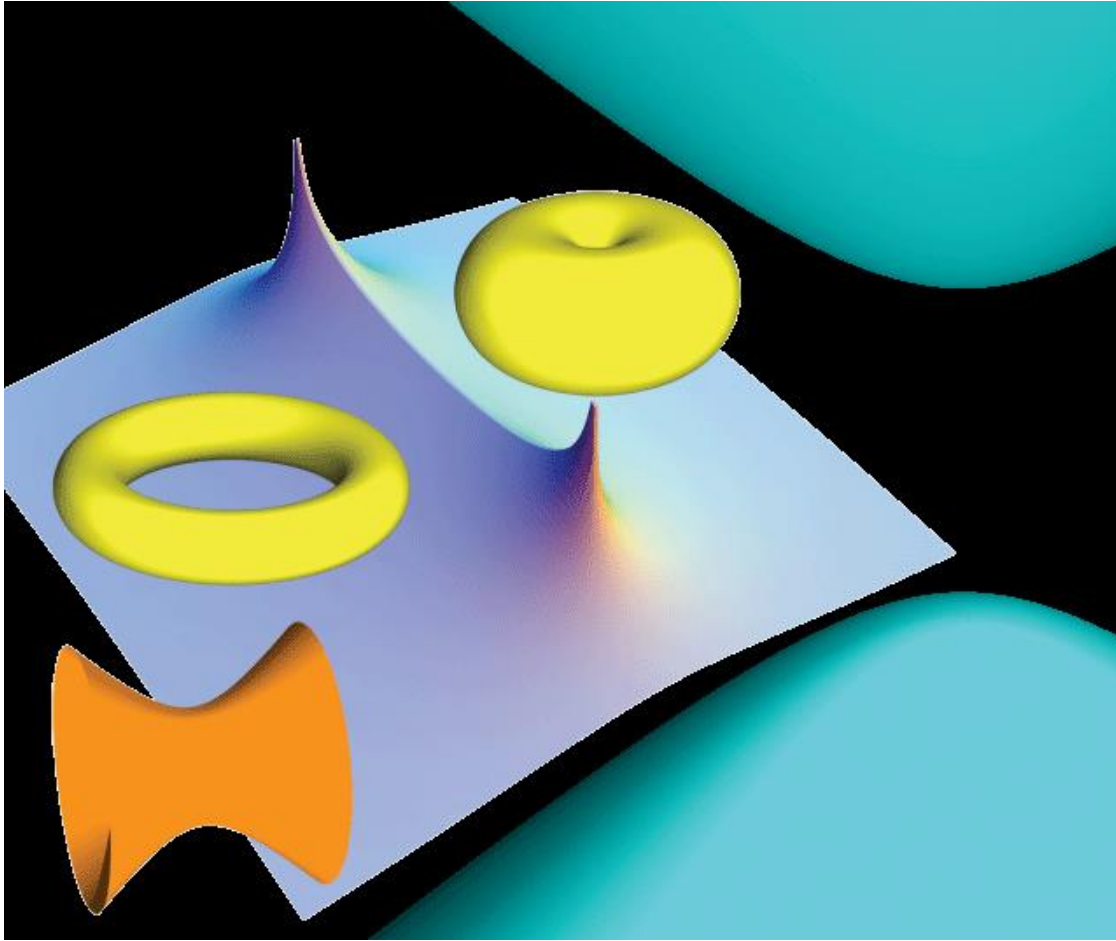

The purple peaks show the gauge coupling of the Seiberg-Witten theory as a function of the moduli space; the associated tori are shown in yellow. The quantum deformed moduli space of SUSY QCD is shown in turquoise. A slice of anti-de Sitter space is shown in orange.

From Monograph by Terning:

<http://particle.physics.ucdavis.edu/modernsusy/index.html>

Looking to quantize gravity

- At the LHC we can explore many of the theories that have been formulated to explain why gravity is so much weaker than the other forces .
- More on that later.

Summary so far

- We must understand the fundamental particles and the forces that govern their interactions to understand the structure of the universe.
- Unfortunately
 - We don't know what most of the universe is made out of.
 - We have an incomplete understanding of the forces – in particular gravity
- Fortunately – The LHC is turning on!

New Instruments, New Science

- The amazing results that have been coming from astronomy/cosmology are in no small part due to the amazing facilities that have been operating (Hubble, WMAP...)



- Now a new accelerator facility is going to come online and one expects equally interesting results
- And some will be of Cosmological interest
 - I will give some examples of cosmologically interesting things we can measure.
 - But first, the experiment!

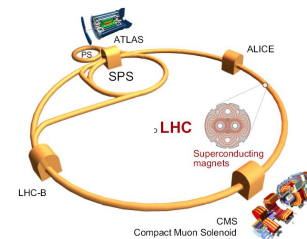

LHC

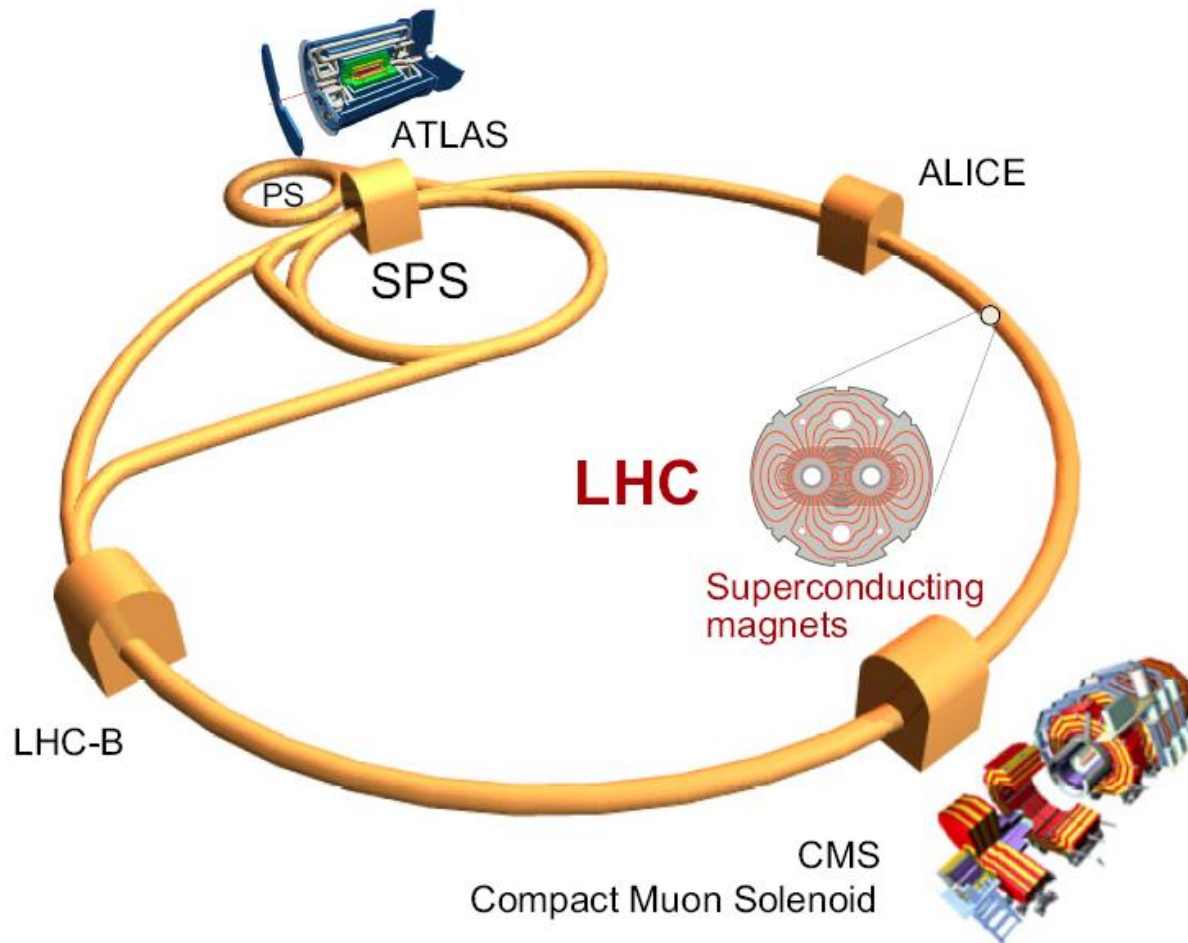



http://www.nytimes.com/ref/science/20070514_CERN_GRAPHIC.html

Some Factoids

- The Large Hadron Collider at Cern has been installed in a tunnel 27km in circumference, buried 100m underground.
- It will produce head-on collisions between two beams of particles travelling through a vacuum comparable to outer space.
- Each beam will consist of almost 3000 bunches of 100 billion particles each.
- At full power, each beam will be about as energetic as a car moving at 1600 kph.
- At near light speed, a proton in the LHC beam will make 11,245 laps a second.
- A beam might circulate for 10 hours, travelling more than 10 billion kilometres - far enough to get to the planet Neptune and back.
- 3000km of wires and fibres will carry information at the rate of 3200 terabytes per year, equivalent to around 3 billion books.

ATLAS A Toroidal LHC Apparatus

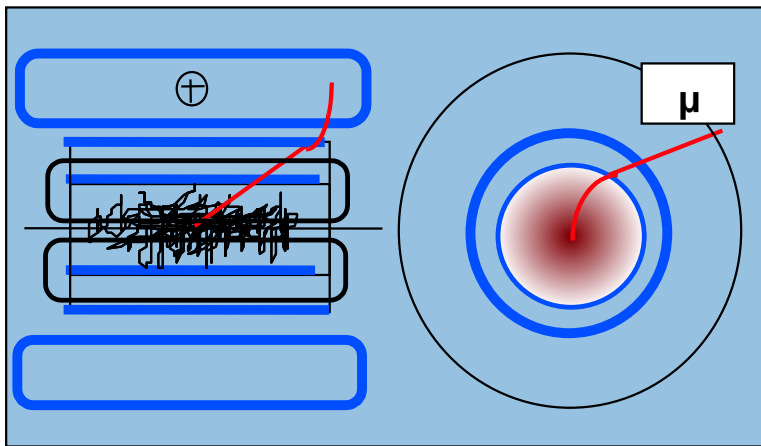
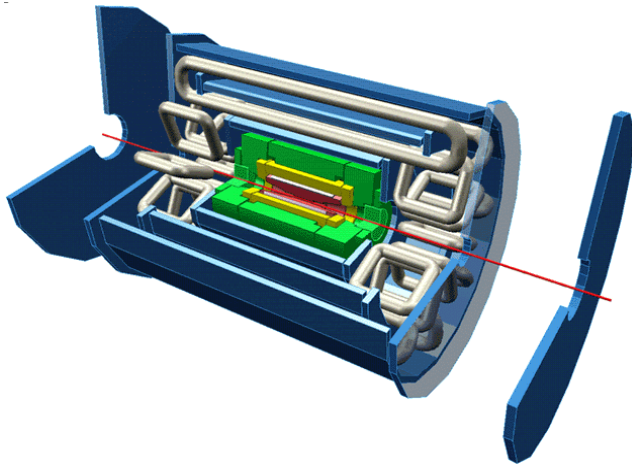

CMS Compact Muon Solenoid

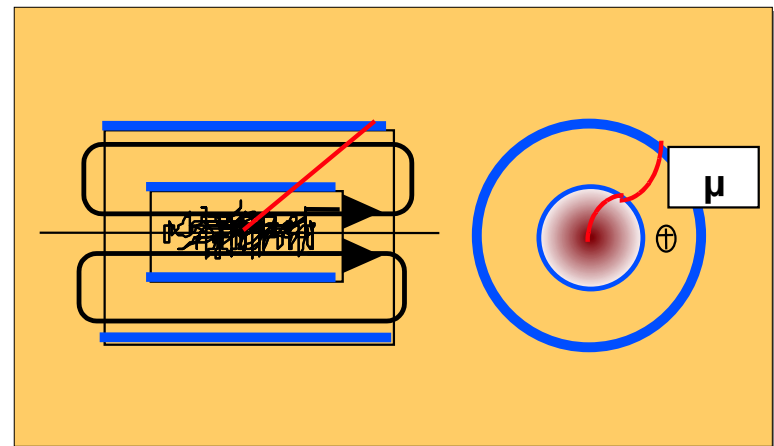
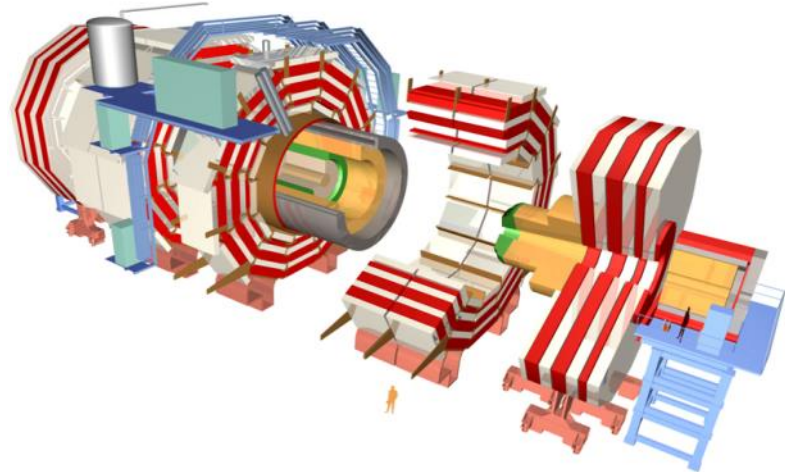

Compact is a relative term

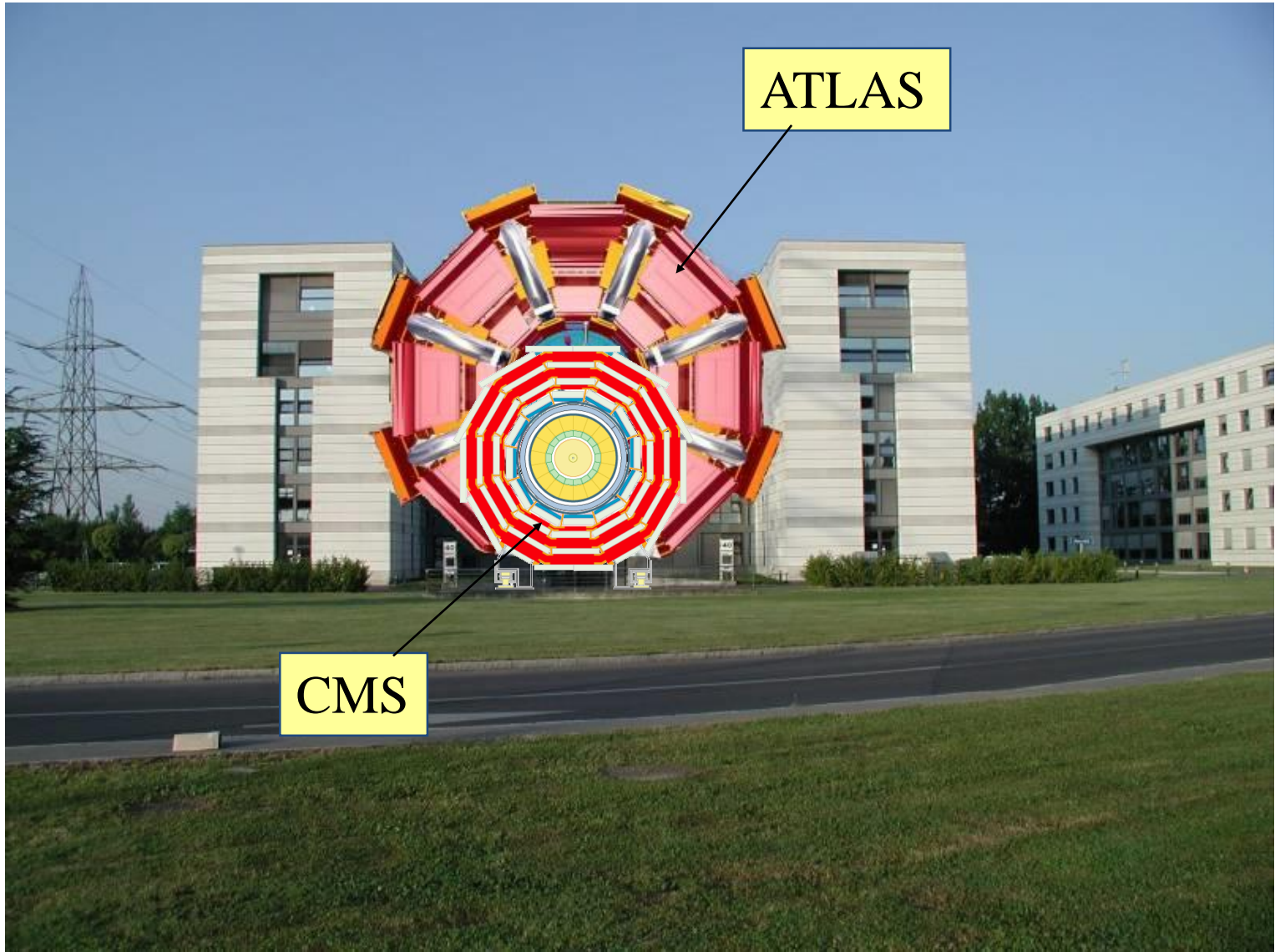

Compact is a relative term:

CMS contains more steel than the Eiffel tower and weighs more than ATLAS

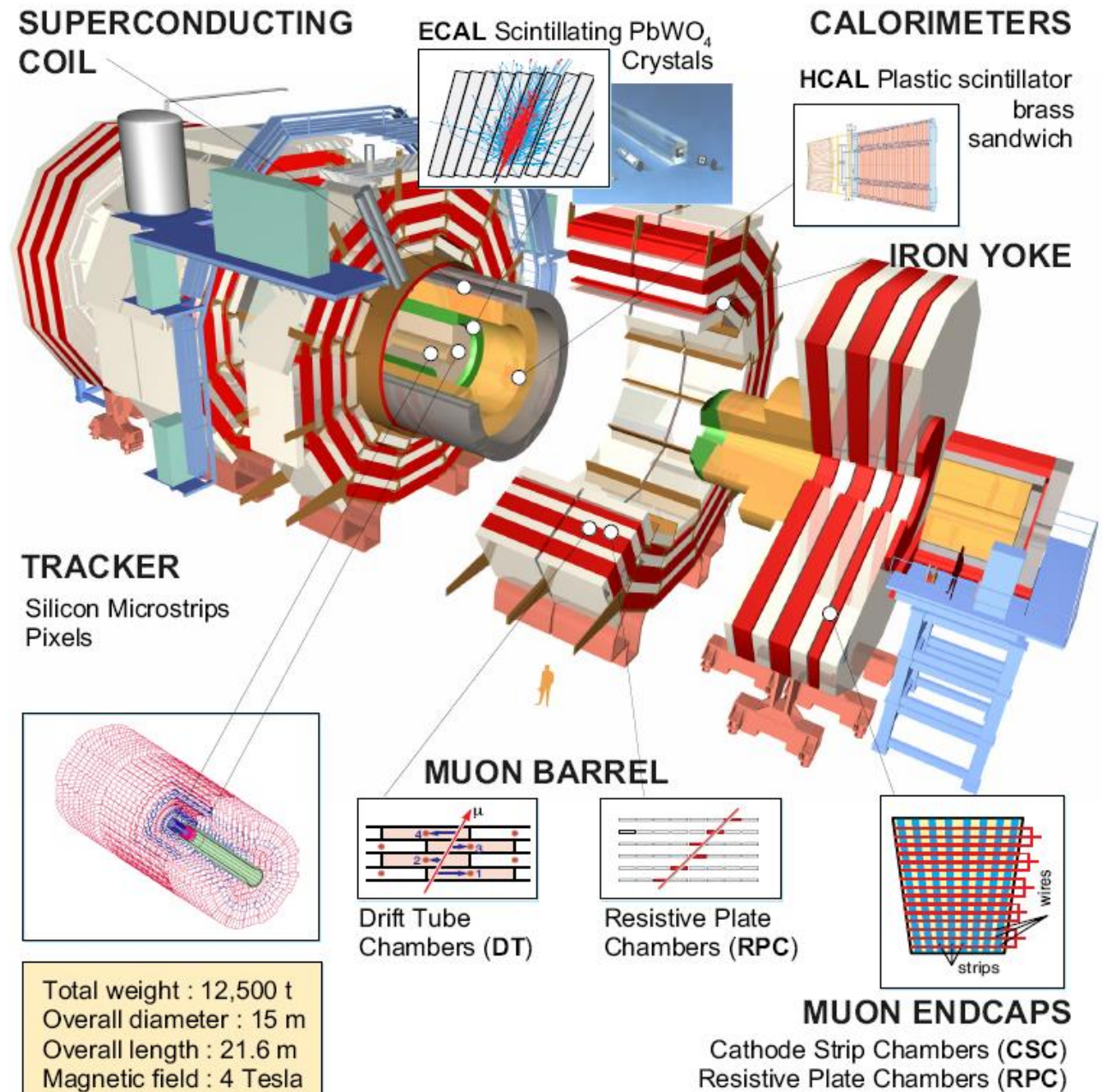

37 Countries, 155 Institutes, 2000 scientists (including about 400 students) October 2006

TRIGGER, DATA ACQUISITION & OFFLINE COMPUTING

Austria, Brazil, CERN, Finland, France, Greece, Hungary, Ireland, Italy, Korea, Poland, Portugal, Switzerland, UK, USA

TRACKER

Austria, Belgium, CERN, Finland, France, Germany, Italy, Japan*, Mexico, New Zealand, Switzerland, UK, USA

CRYSTAL ECAL

Belarus, CERN, China, Croatia, Cyprus, France, Italy, Japan*, Portugal, Russia, Serbia, Switzerland, UK, USA

PRESHOWER

Armenia, CERN, Greece, India, Russia, Taiwan

RETURN YOKE

Barrel: Czech Rep., Estonia, Germany, Greece, Russia
Endcap: Japan*, USA

SUPERCONDUCTING MAGNET

All countries in CMS contribute to Magnet financing in particular:
Finland, France, Italy, Japan*, Korea, Switzerland, USA

FEET
Pakistan
China

FORWARD CALORIMETER
Hungary, Iran, Russia, Turkey, USA

HCAL

Barrel: Bulgaria, India, Spain*, USA
Endcap: Belarus, Bulgaria, Georgia, Russia, Ukraine, Uzbekistan
HO: India

MUON CHAMBERS

Barrel: Austria, Bulgaria, CERN, China, Germany, Hungary, Italy, Spain,
Endcap: Belarus, Bulgaria, China, Colombia, Korea, Pakistan, Russia, USA

* Only through industrial contracts

Total weight : 12500 T
Overall diameter : 15.0 m
Overall length : 21.5 m
Magnetic field : 4 Tesla

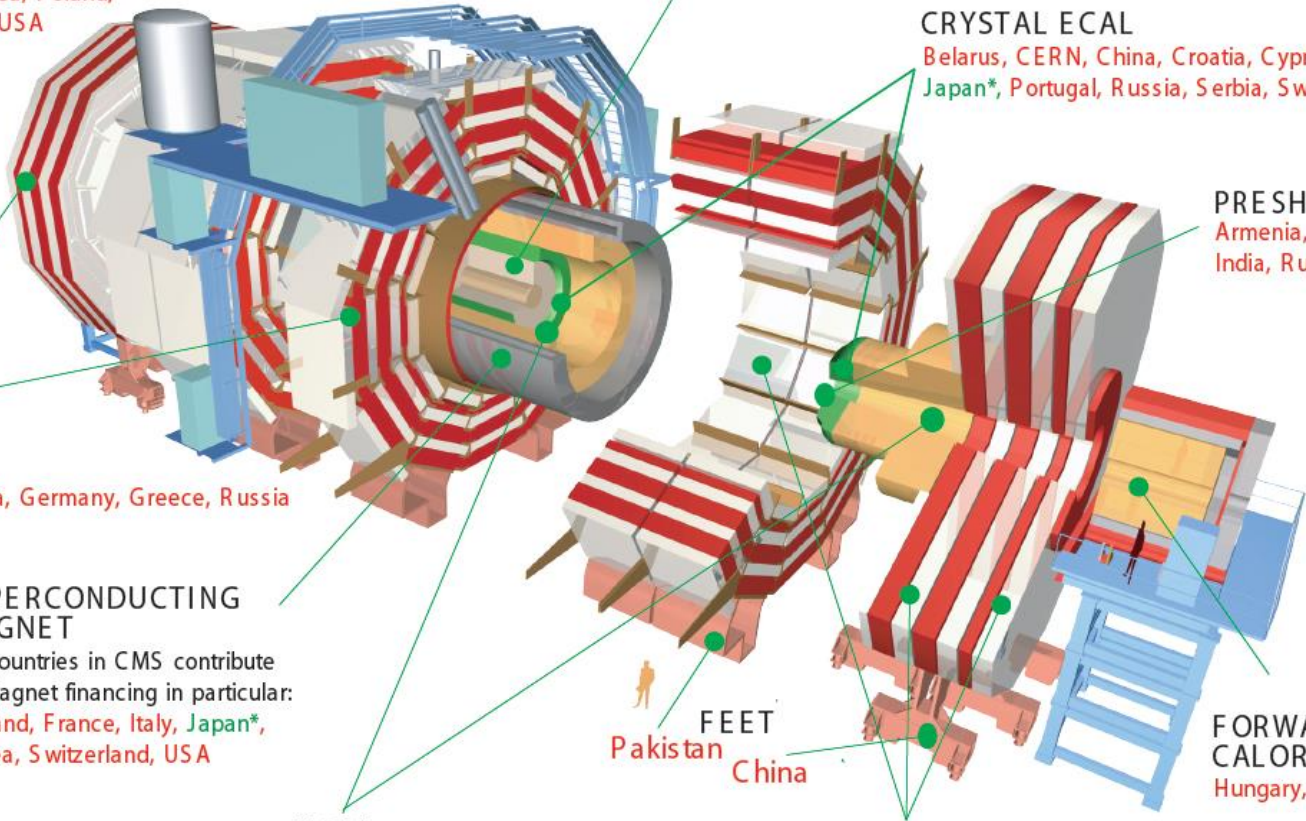

Beginning Construction 1998









Assembly on Surface

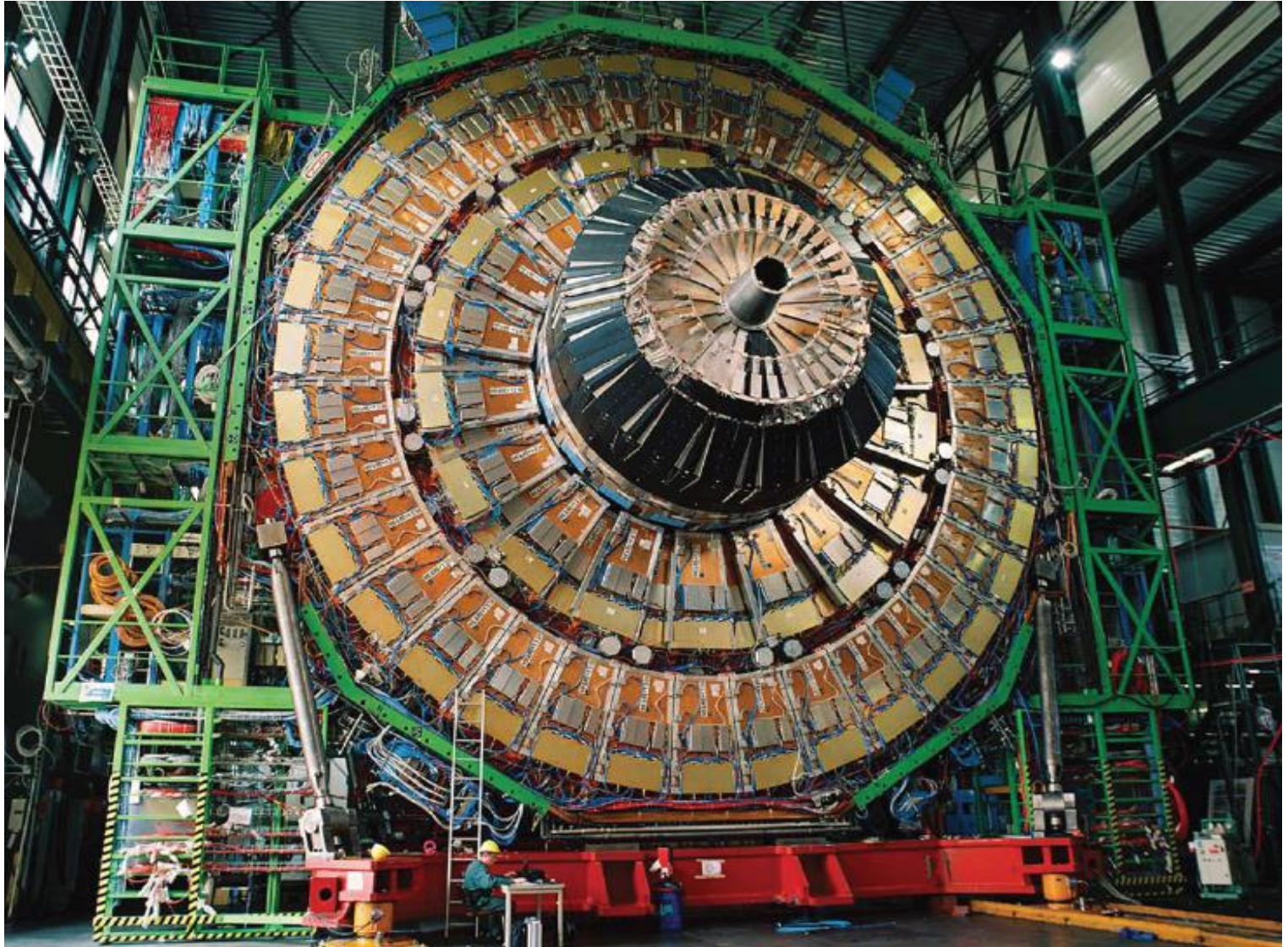

Lowering

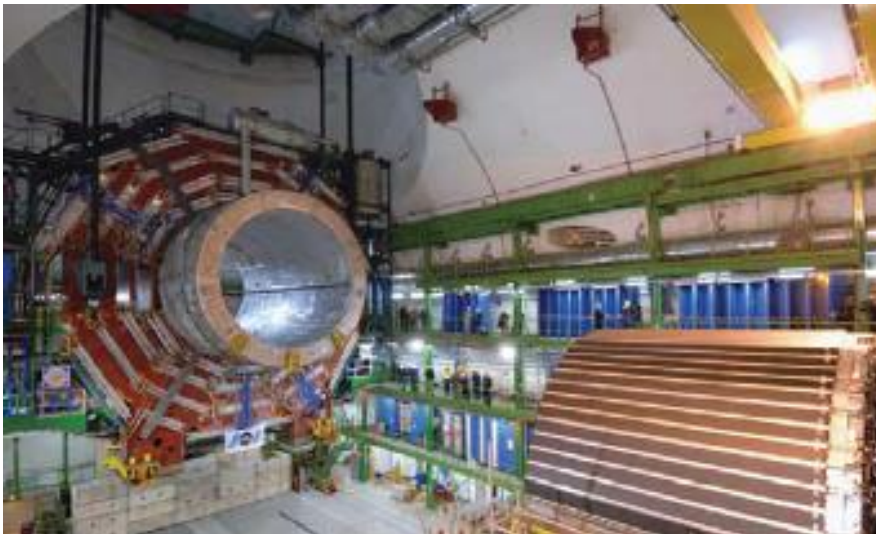

Lowering



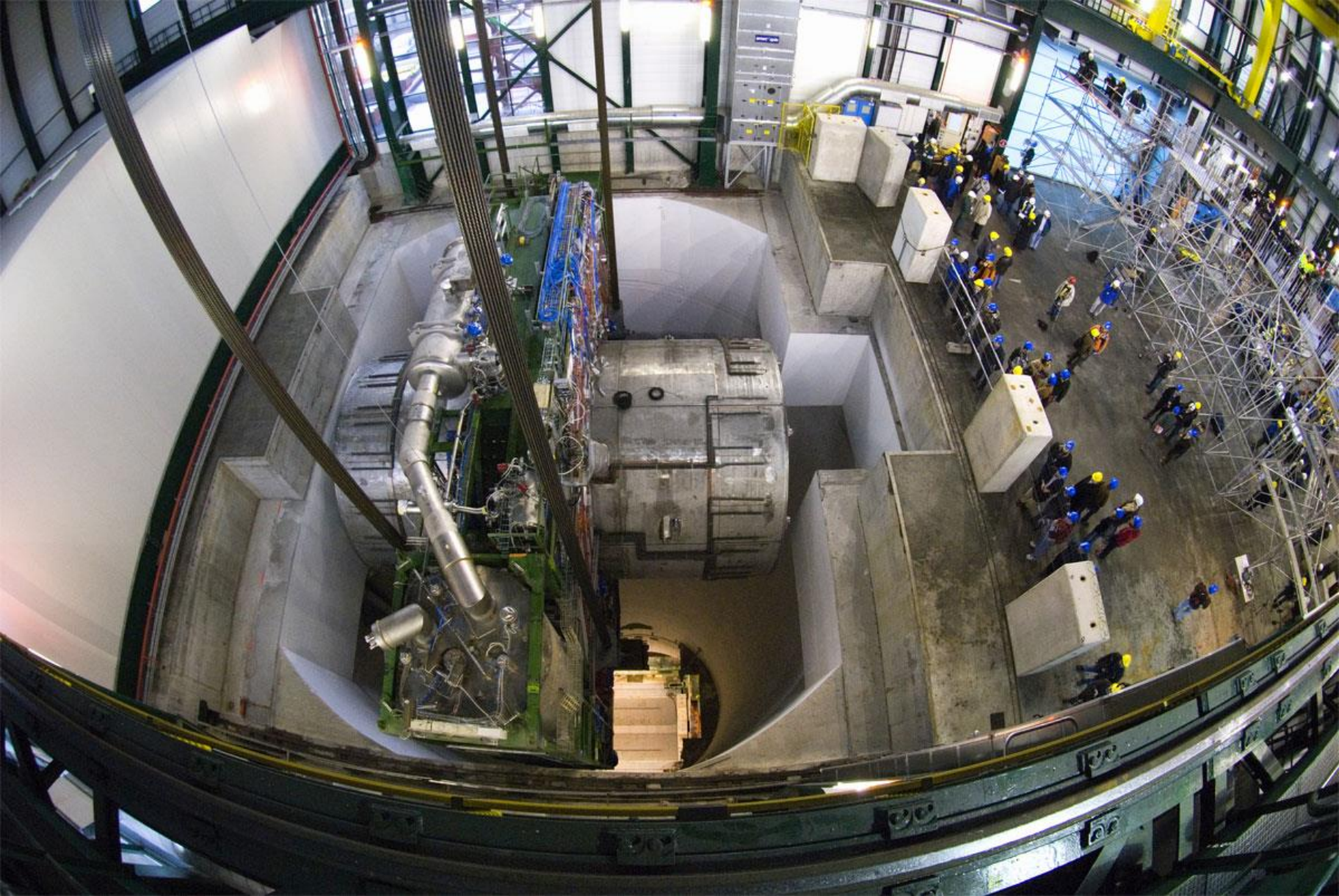

1920 Tonne piece of detector, with superconducting magnet being lowered down.



Example Production Rates

$$\mathcal{L} = 2 \times 10^{33} \text{ cm}^{-2} \text{ s}^{-1}$$

Process	Number of Events/year
W->ev	400,000,000
Z->ee	40,000,000
ttbar	16,000,000
bbar	10,000,000,000,000
Gluino gluino (m=1TeV)	20,000
Higgs 120GeV	800,000

There are no efficiencies or branching ratios taken into account here

At this luminosity collect 20fb^{-1} per year

[Whats a femtobarn?](#)

Luminosity will eventually be in the 10^{34} range

Looking for Dark Matter

Dark Matter Candidates, such as SUSY

Blue arrow is missing transverse energy

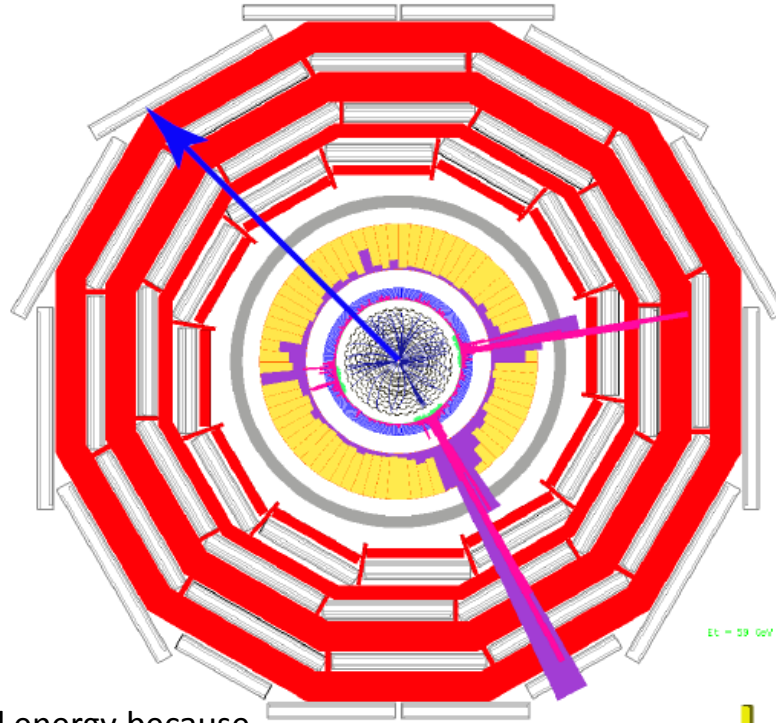

Nomenclature – we use the word energy because in practice what we do is measure energies in the detector, make it a vector presuming E and P are the same (a good assumption at our energies) and then sum up that calling the resulting quantity transverse energy

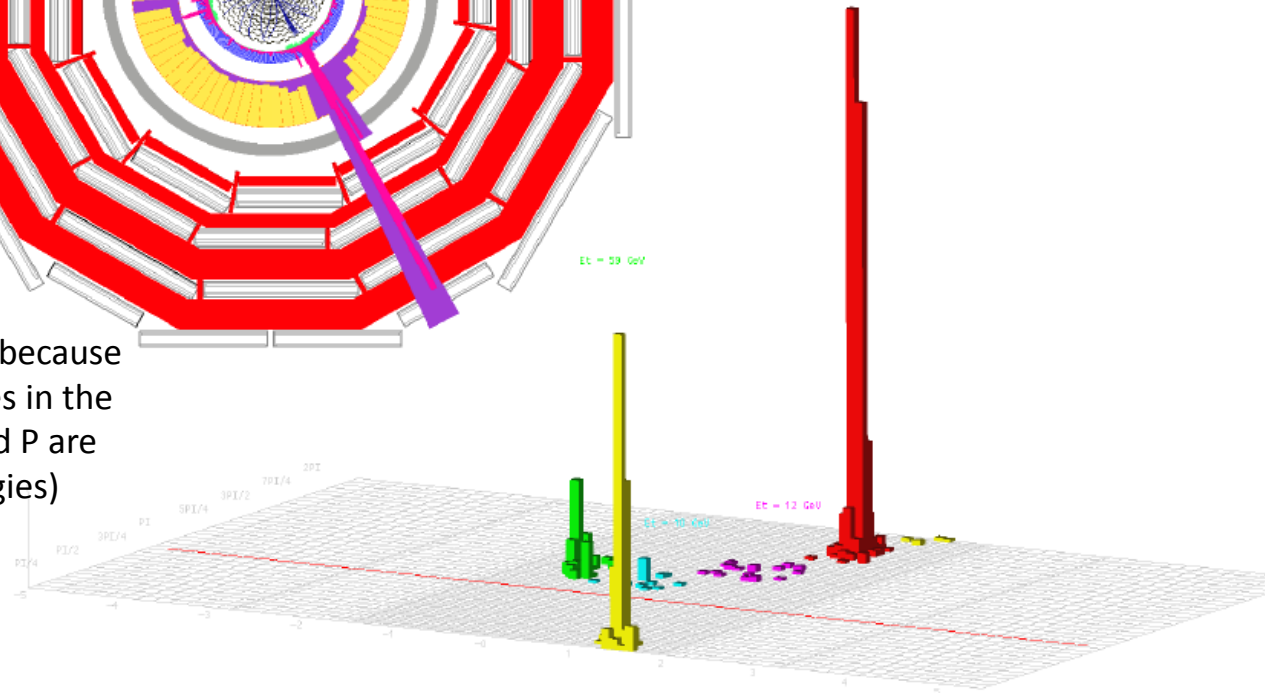

Missing Et ?

A trigger on E_T provides an excellent test sample for data quality control:

D0

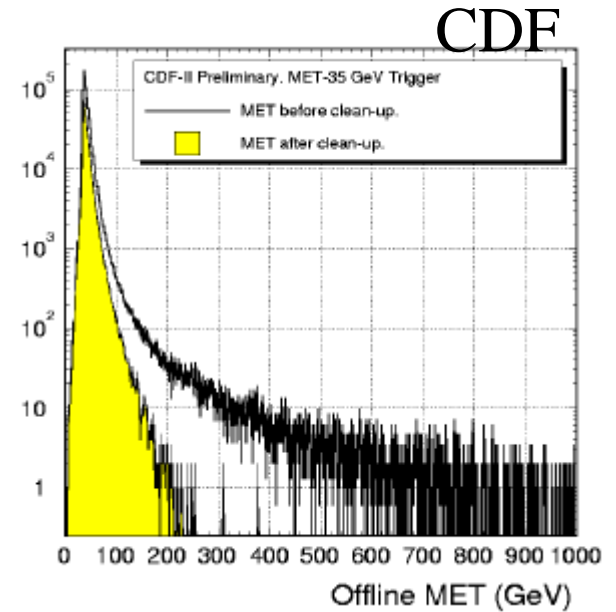
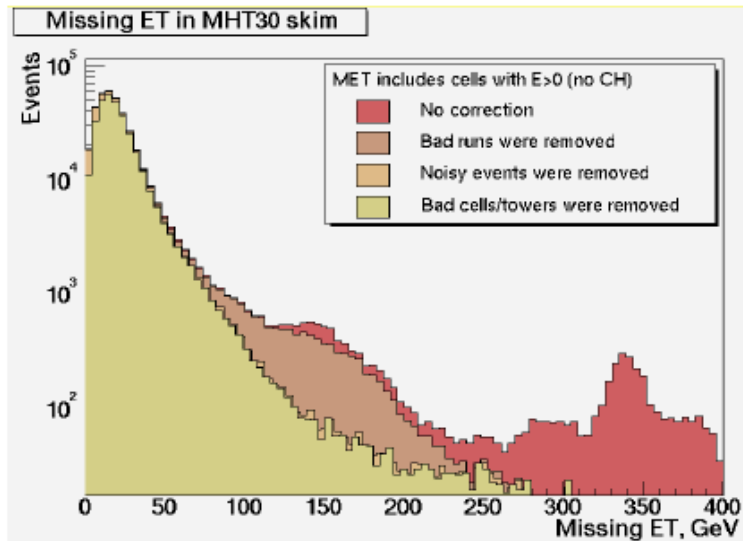

Run II at CDF and D0 shows that with all the preparation MET is hard to do.

Need to establish MET before searching for SUSY.

Must understand the detector well

- In order to see evidence of dark matter by the “missing energy”
- So we will see lots of missing energy in the initial running of CMS and it will be evidence of detector problems as we shake out our understanding of the detector.
- We will get there, and will search and if dark matter is to be discovered, do so.
- But not in 2009

We will get there

- We will ultimately understand our detector very well and will be very well equipped to find SUSY, i.e. we will recognize missing energy and will be able to determine if it is coming from new physics or not.

Looking for Extra dimensions

Looking for Extra Dimensions

- Many theories invoke extra dimensions to explain why gravity is weak
- If such a theory explains the difference between the strength of electromagnetism and gravity we might be able to find evidence for the extra dimensions

Kaluza-Klein

- You will often hear reference to Kaluza-Klein excitations, and that is certainly something we will look for at the LHC.
- Google Scholar hits on Kaluza Klein as a function of year.
- More than 1000 in the preprint arxiv
- So I thought I will give my simple minded experimentalist's explanation of what these are.

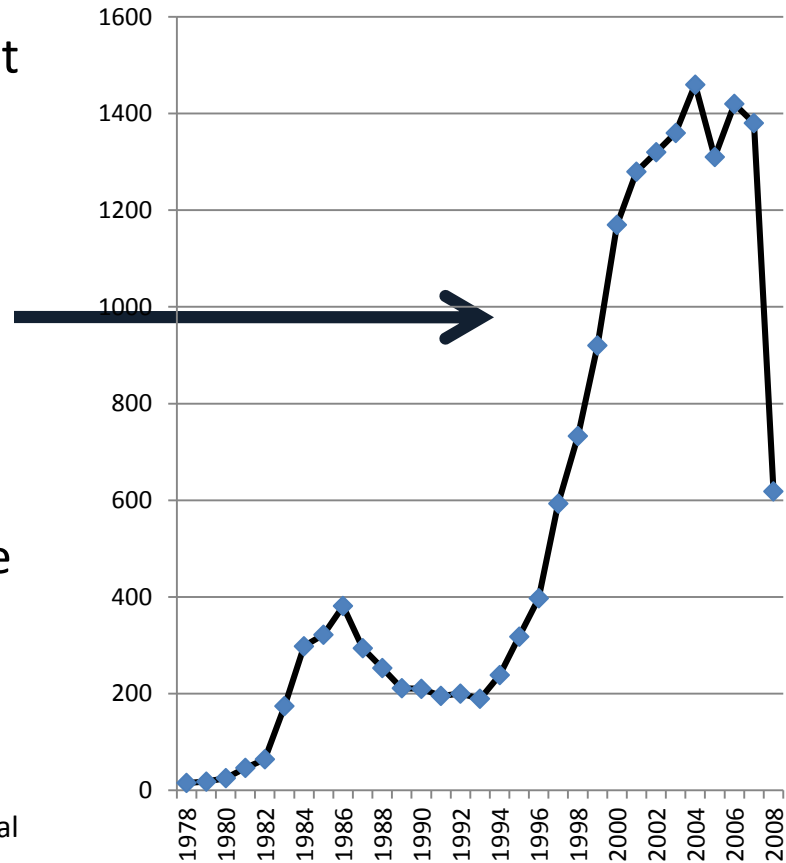

The drop in 2008 is because I made the plot in the summer, final number for last year is 1310

Undergraduate Quantum

- Remember your undergraduate quantum mechanics.
- If a free particle is traveling through the vacuum, you can describe it with a wave packet.

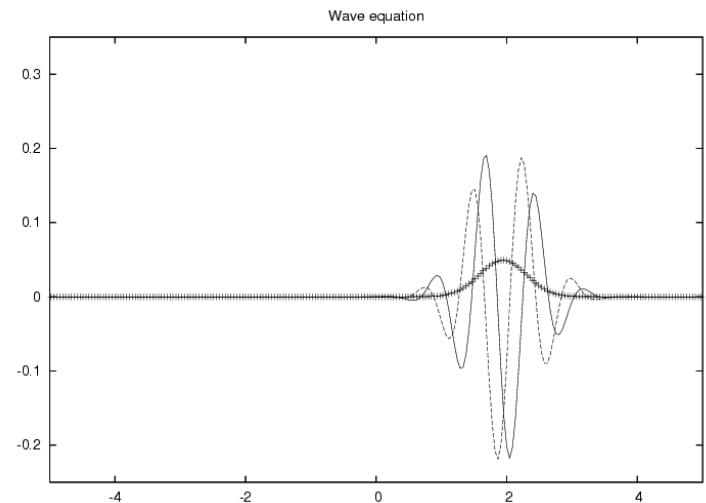

<http://www.cs.unm.edu/~dstrain/sem/results.html>

Undergraduate Quantum

- If a particle is trapped in a box you describe it as a summation of normal modes of the box

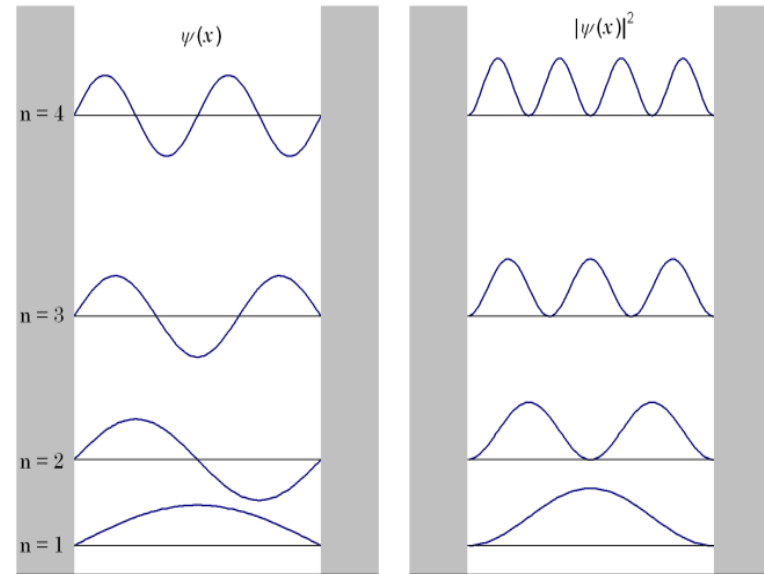

Undergraduate Quantum

- In a Benzene ring you can calculate the energy levels for an electron going around the ring.
- Again you get normal modes
- These correspond to matching the phase and amplitude at the $\phi=0, \phi=2\pi$ boundary
 - m quantum number in the hydrogen atom is the same thing.

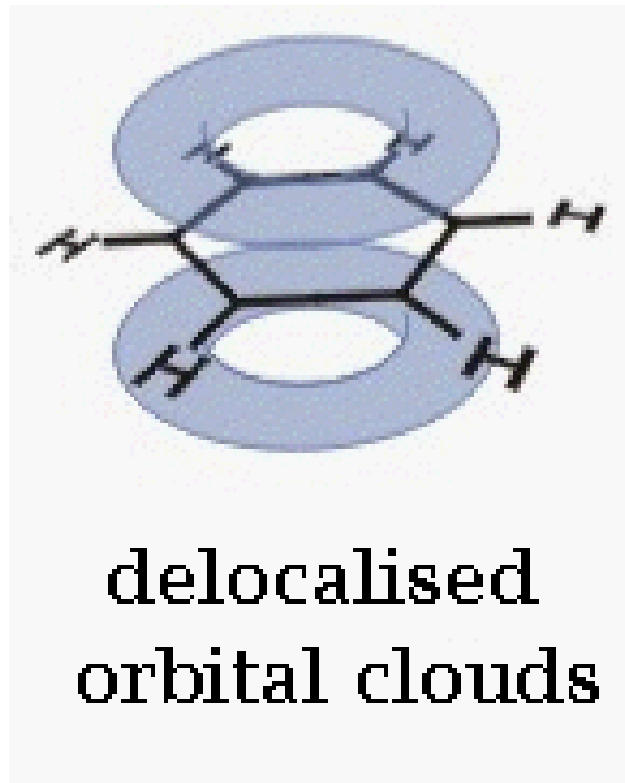

Compact Extra Dimensions

- When you have a particle traveling in compact extra dimensions as well as our space you get a mixture of these two things.
- In our space there is a wave packet
- In the compact space there are normal modes
- These must be combined to get the complete description of the particle

Normal Modes = Mass Bumps

- In our space we see the normal modes of the other dimensions as excited states.
- That is: If a particle is traveling in both the extra dimensions and our space then we will see a tower of mass excitations corresponding to the normal modes in the compacted extra dimensions.

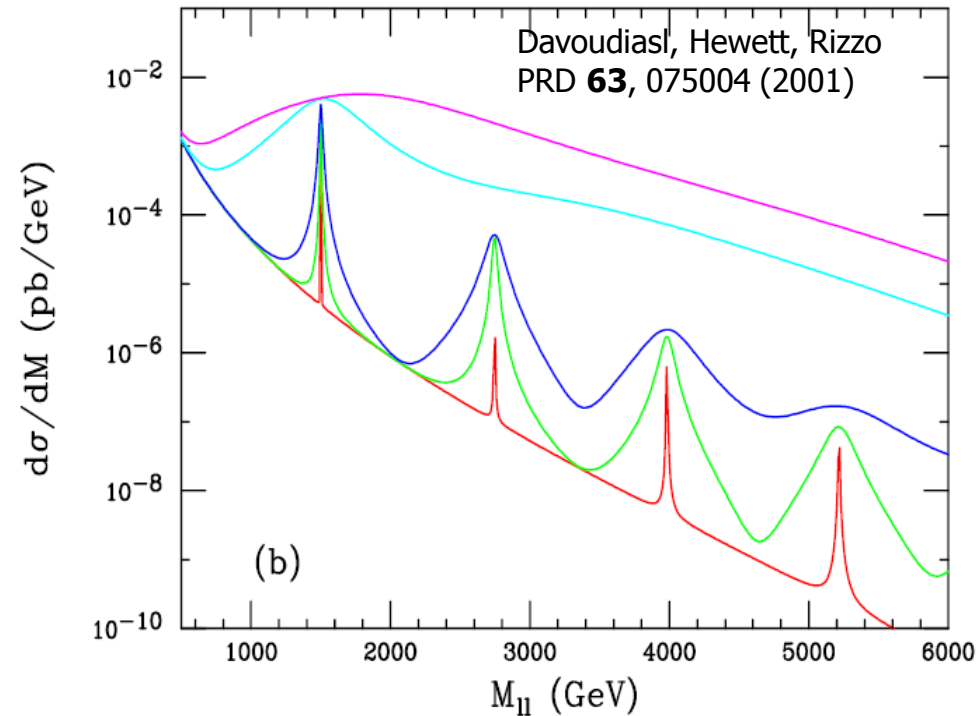

1.5TeV/ c^2 Graviton for various values of k/M_{pl} in \bar{D} rell-Yan production

Drell-Yan

Drell-Yan Process

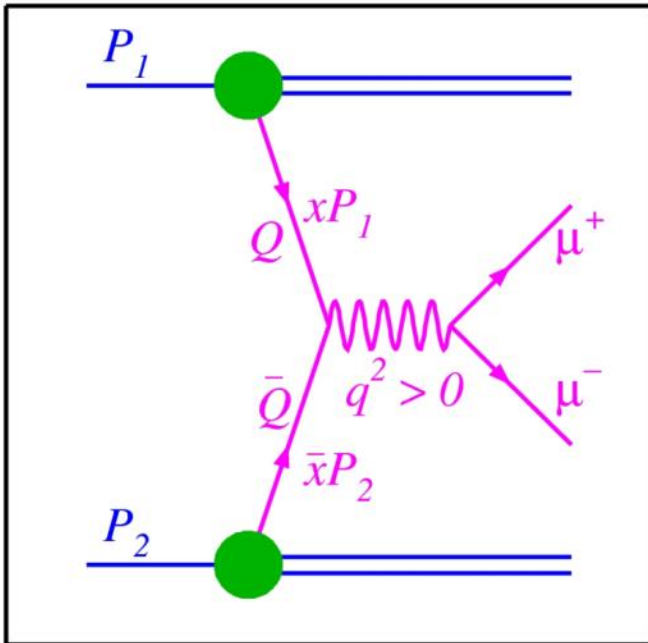

Not just muons, any lepton pairs can come out

- This is fantastic:
 - The first thing we will study at the LHC is the Drell-Yan processes.
 - These are a way we calibrate the detector (we look for the Z^0 , our calibration signal)

Dilepton

- At CMS we looked at possibility of observing resonance peaks (“bumps”) that are predicted by various models
- These usually are KK excitations of a Graviton and Z boson in several models such as Randall-Sundrum, other ED, etc

Dark Matter Candidates

- As well as being evidence for extra dimensions of space and time. These are also (in some cases) candidates for the dark matter in the universe.

Simulated Event

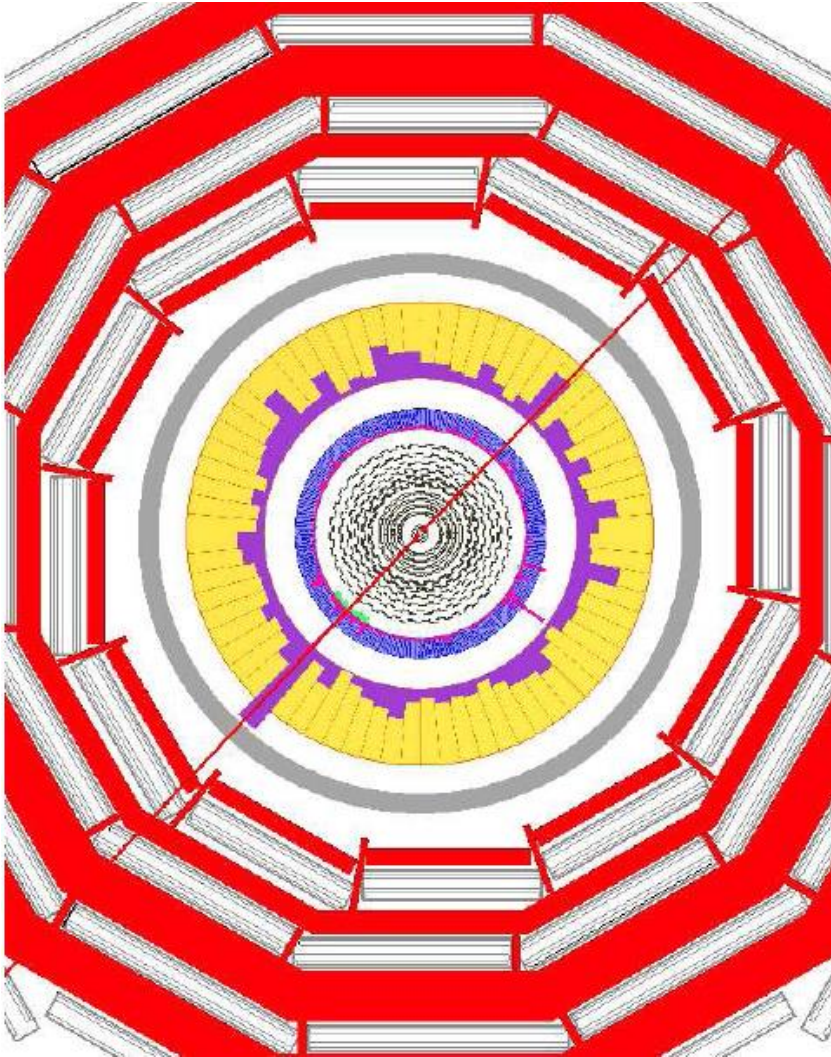

Simulated Z' event decaying to two muons.

This is the easiest thing you can do at the LHC!

Example KK Z

Example of a $4\text{TeV}/c^2$
Kaluza-Klein K with 30fb^{-1}
1

Grey area is the SM Drell-Yan spectrum

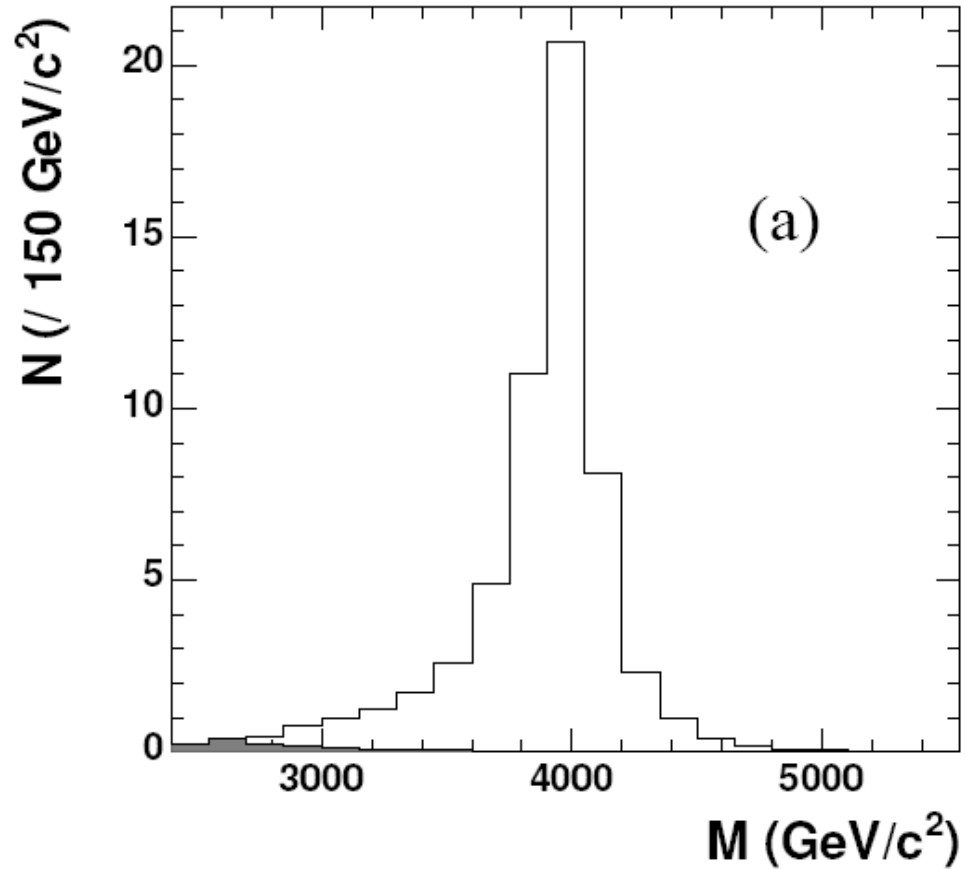

Dimuon “bumps”

Reach of the CMS experiment as a function of the coupling parameter and the graviton mass for various values of integrated luminosity; the left part of each curve is where significance exceeds 5σ

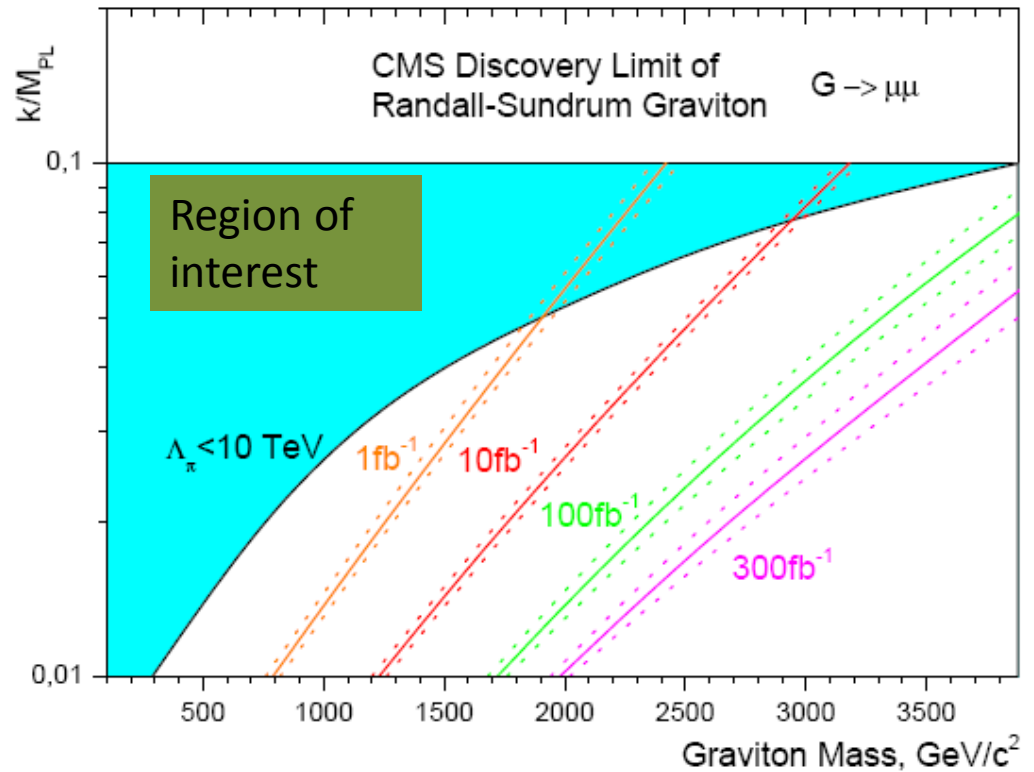

Remember, at nominal luminosity we take 20 fb⁻¹ a year

Dielectron Discovery Potential

Randall-Sundrum type gravitons

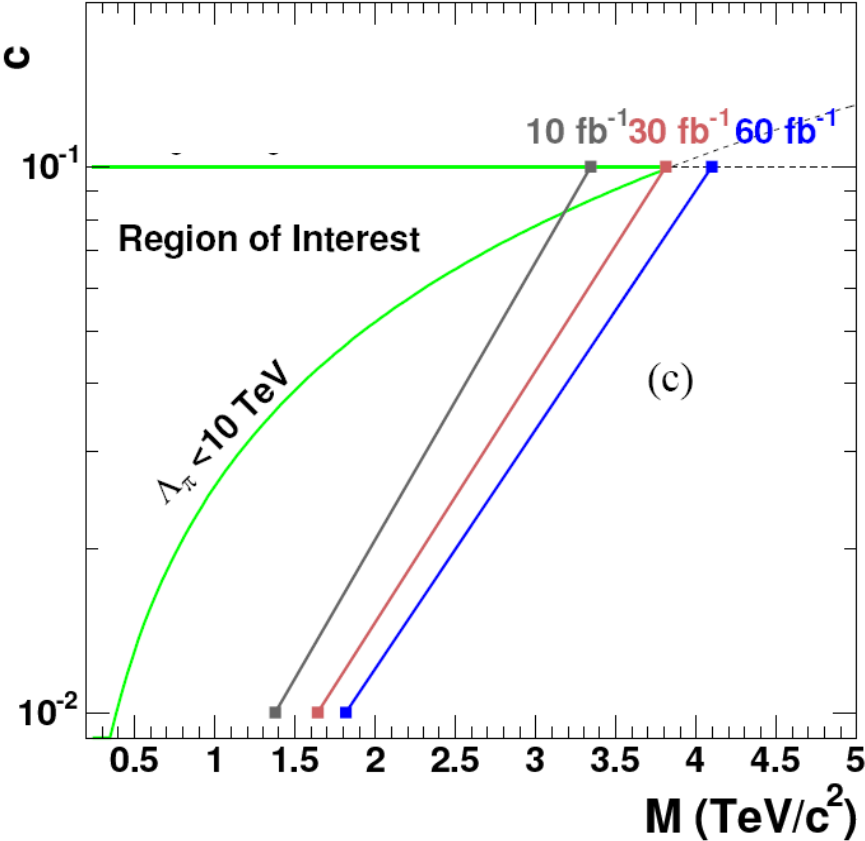

ADD

Arkani-Hamed,
Dimopoulos, Dvali

[If less than 10 minutes
left – follow this link](#)

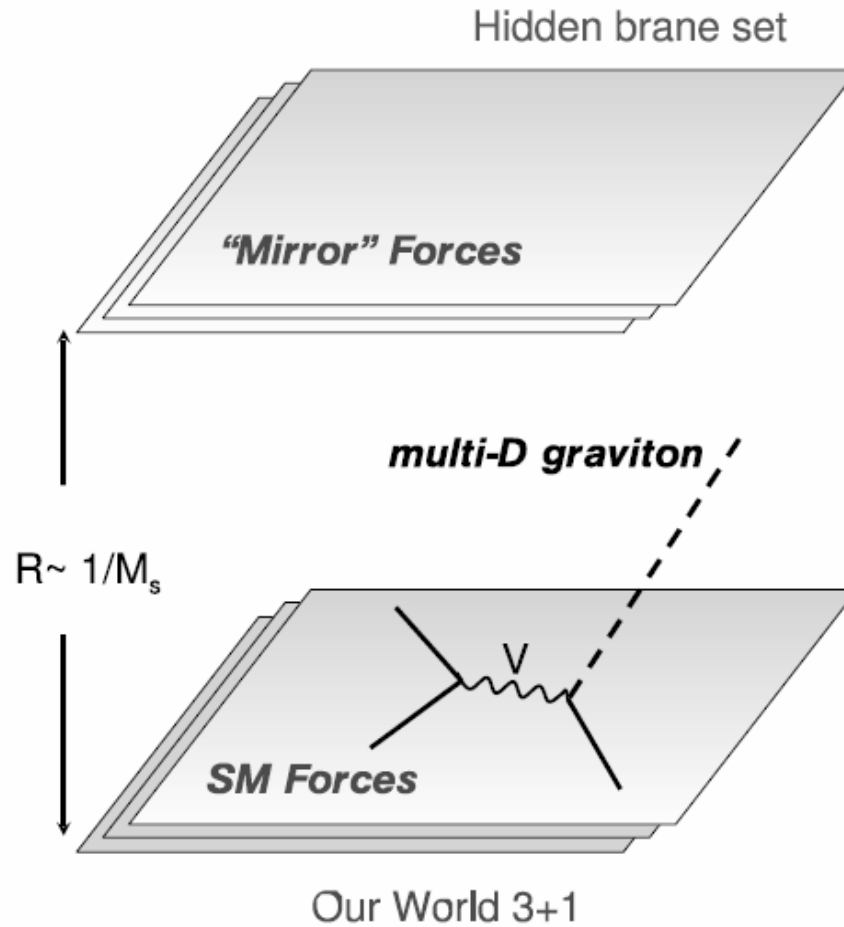

Large Extra Dimensions

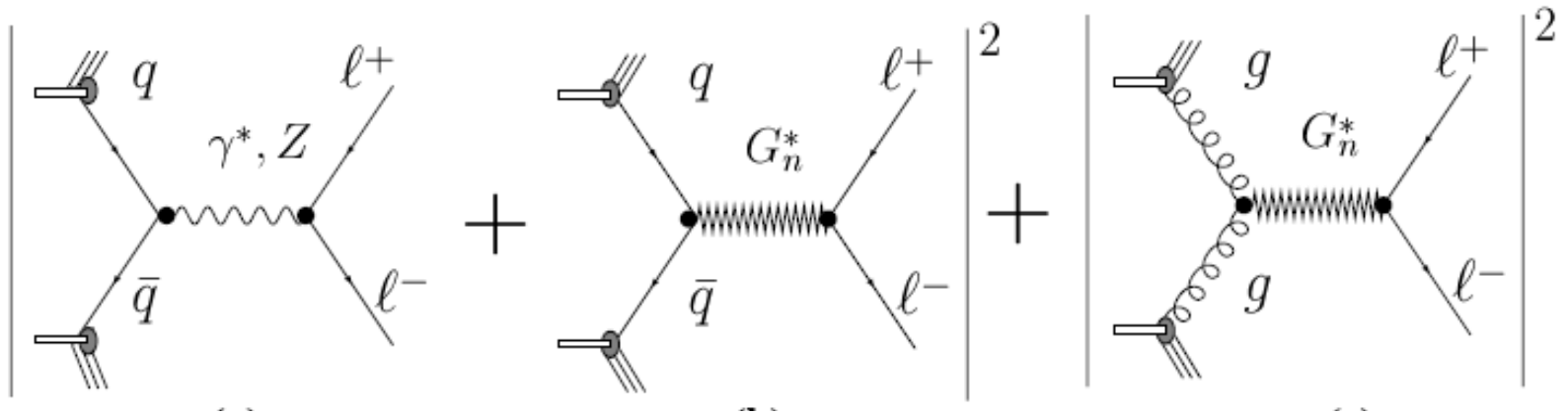

Dimuon spectrum enhancement

- ADD model is expected to be observed via non-resonant modifications to the di-muon spectrum

- Plots at right show this for $n_{\text{extra}}=6$ to 1 (bottom to top)

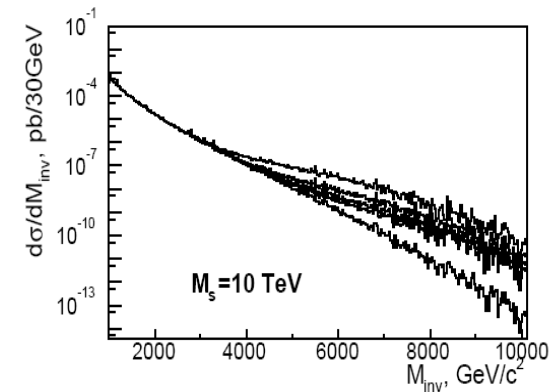
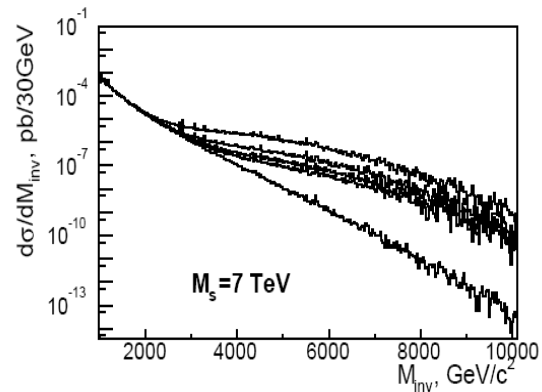
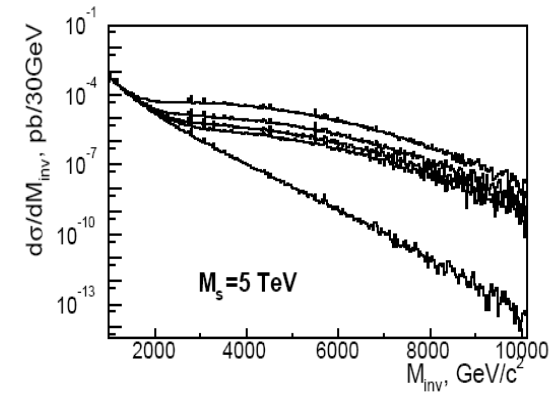
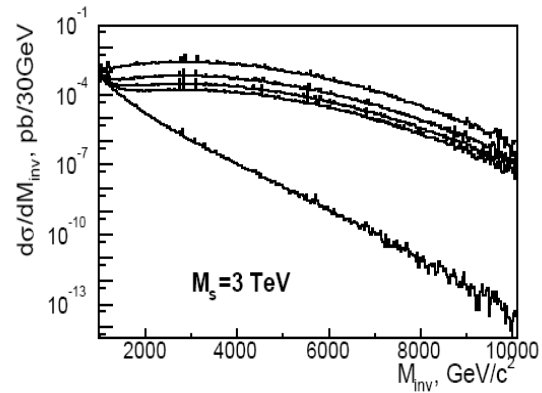

Dimuon spectrum enhancement

- Plot to the right is significance as a function of physics scale:
 - Even for $L=1\text{fb}^{-1}$ ADD contributions to Drell-Yan process discoverable for $M < 4\text{TeV}$

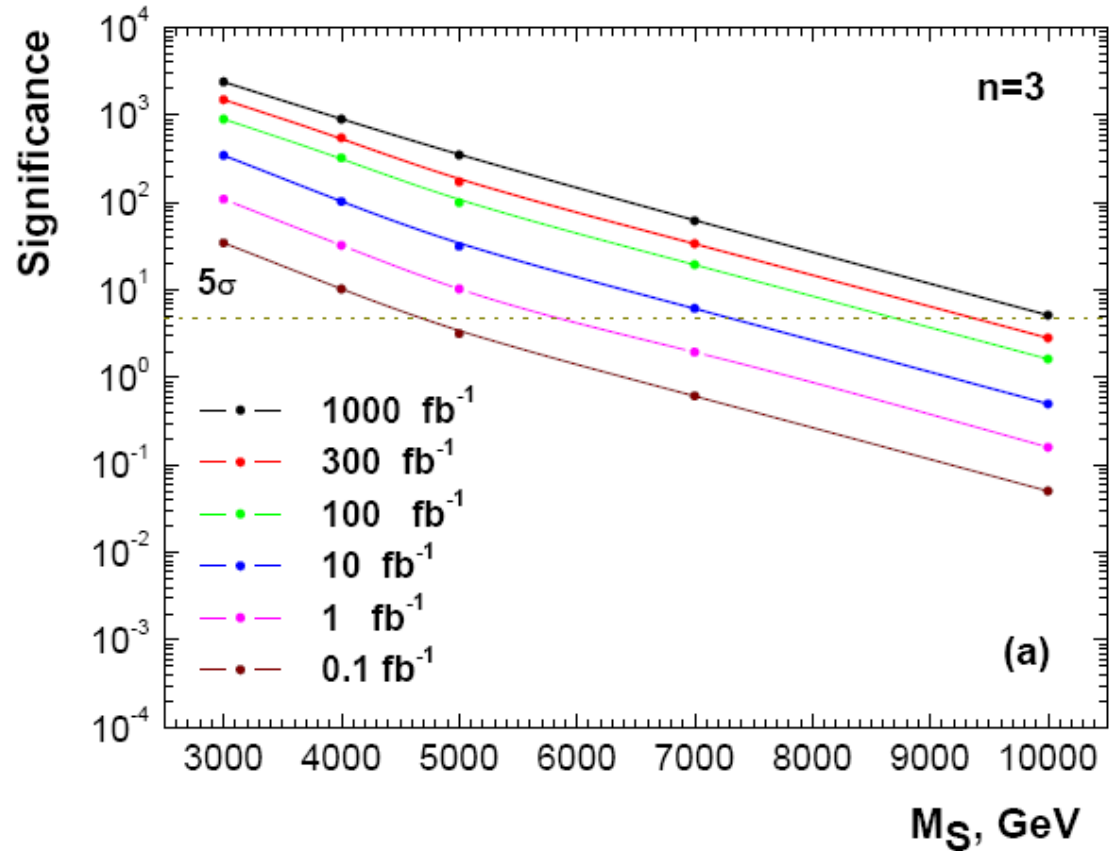

Dimuon spectrum enhancement

- Plot to the right is significance as a function of physics scale:
 - Even for $L=1\text{fb}^{-1}$ ADD contributions to Drell-Yan process show for $M < 4\text{TeV}$

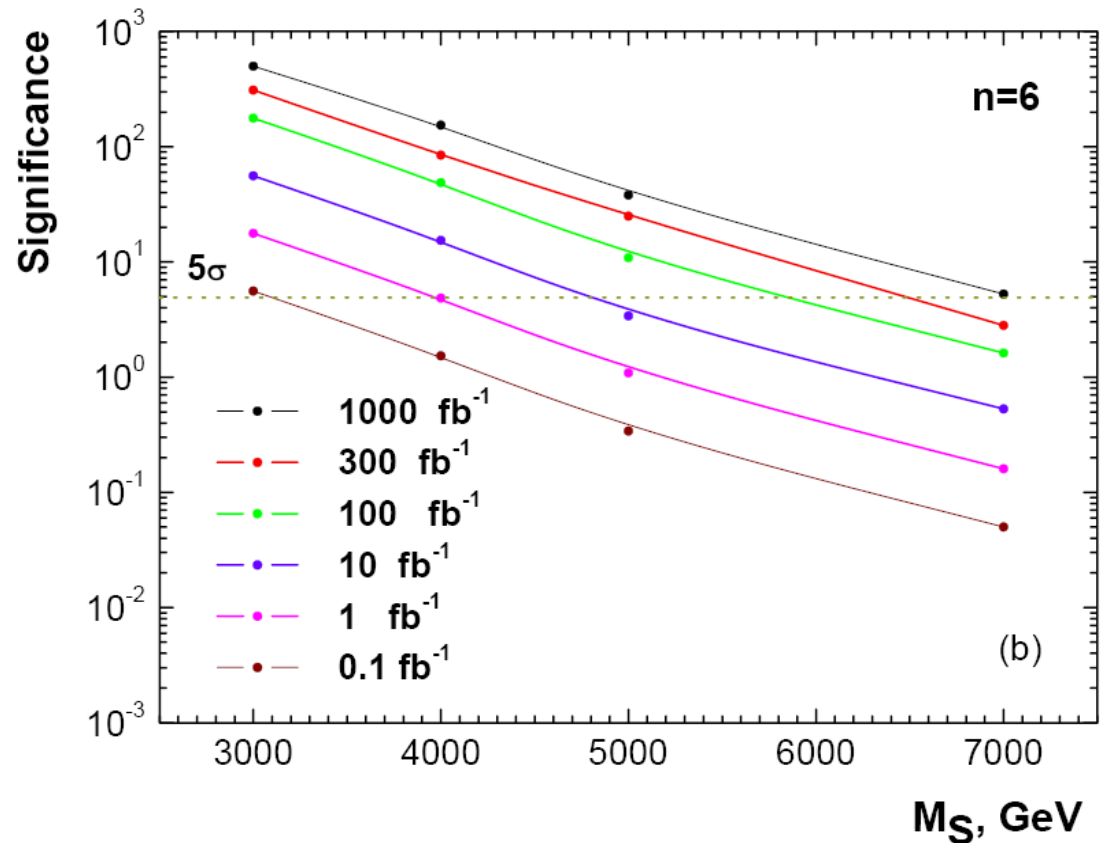

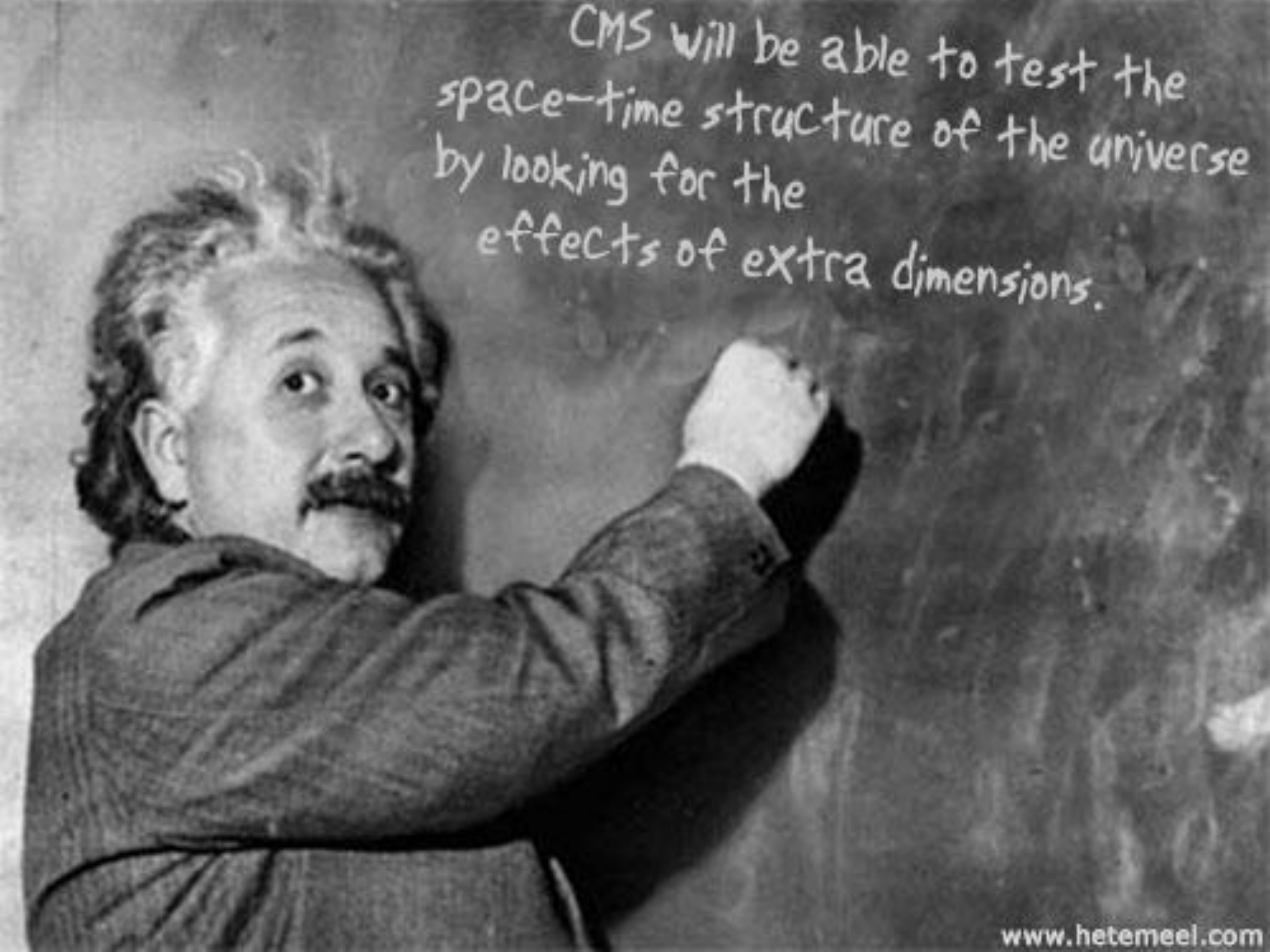
A black and white photograph of Albert Einstein, looking towards the camera with a surprised expression. He is standing in front of a chalkboard. On the chalkboard, there is handwritten text in white chalk. The text reads: "CMS will be able to test the space-time structure of the universe by looking for the effects of extra dimensions." The text is arranged in four lines, slanted upwards from left to right. Einstein's right hand is raised, with his index finger pointing towards the text on the board. He is wearing a dark, long-sleeved jacket or sweater.

CMS will be able to test the
space-time structure of the universe
by looking for the
effects of extra dimensions.

Cosmic- Rays

Run 66748, Event 8860756, LS 160, Orbit 166741956, BX 1921

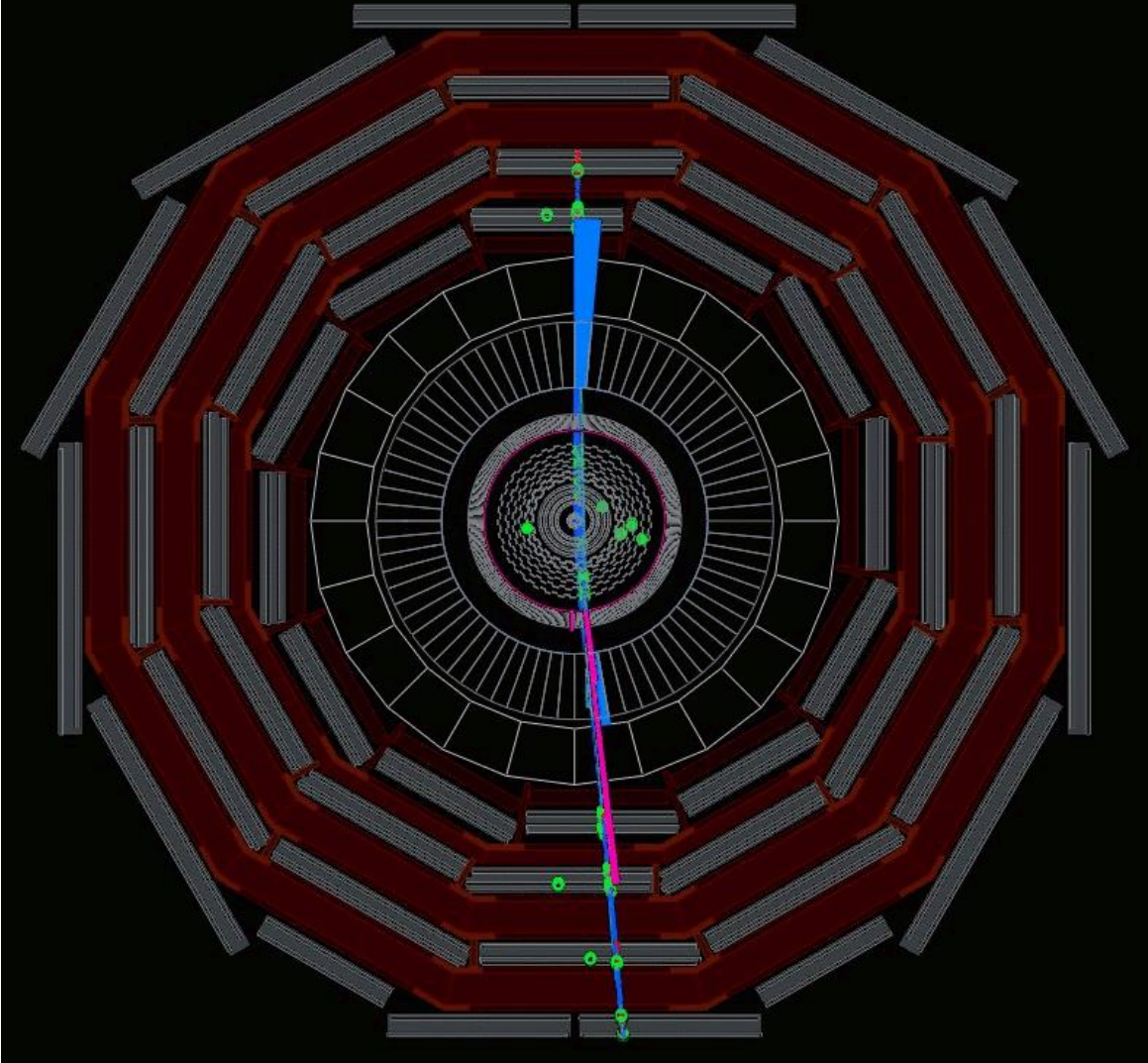

When we don't have beam, we are able to commission the detector using cosmic rays.

September 10th

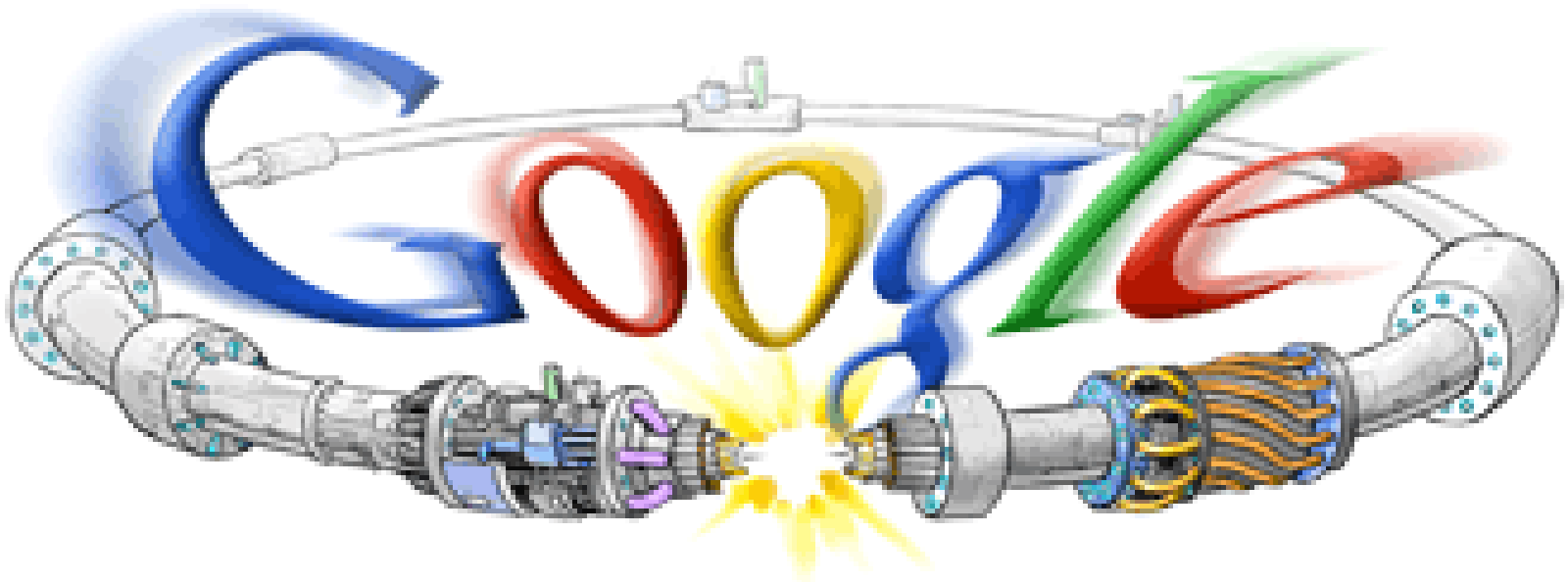

Beam

Run No. 62063, Evt# 1534, Sep. 10, 2008 09:38:21

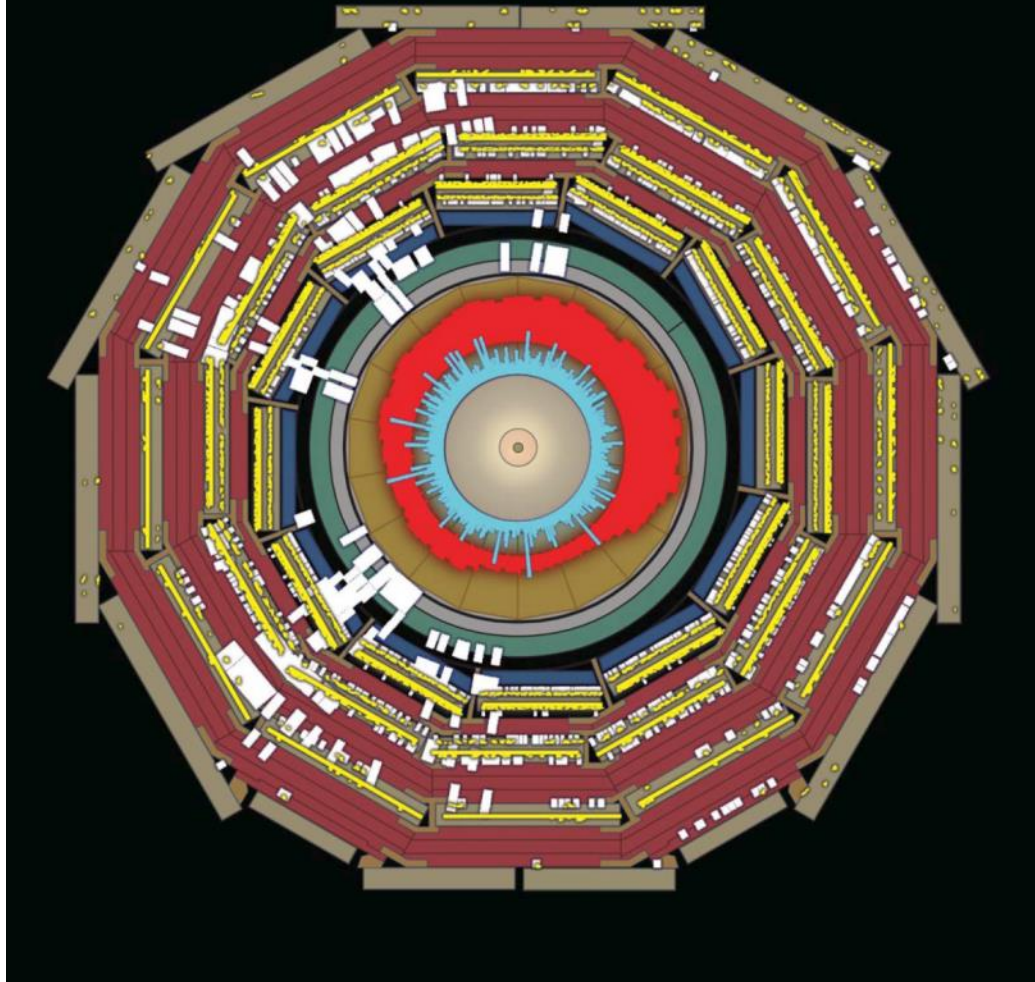

Dipole

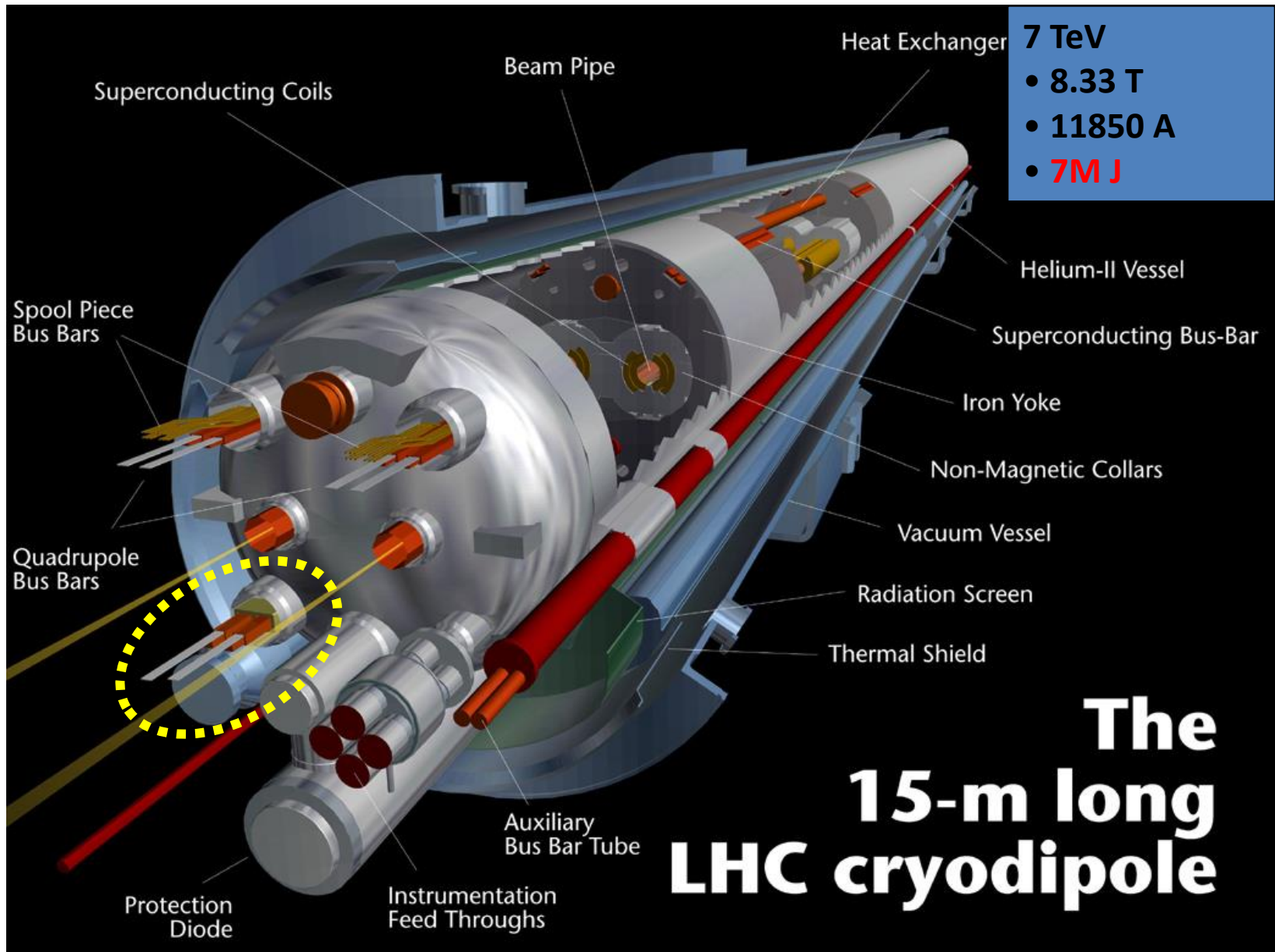

Inter-connection

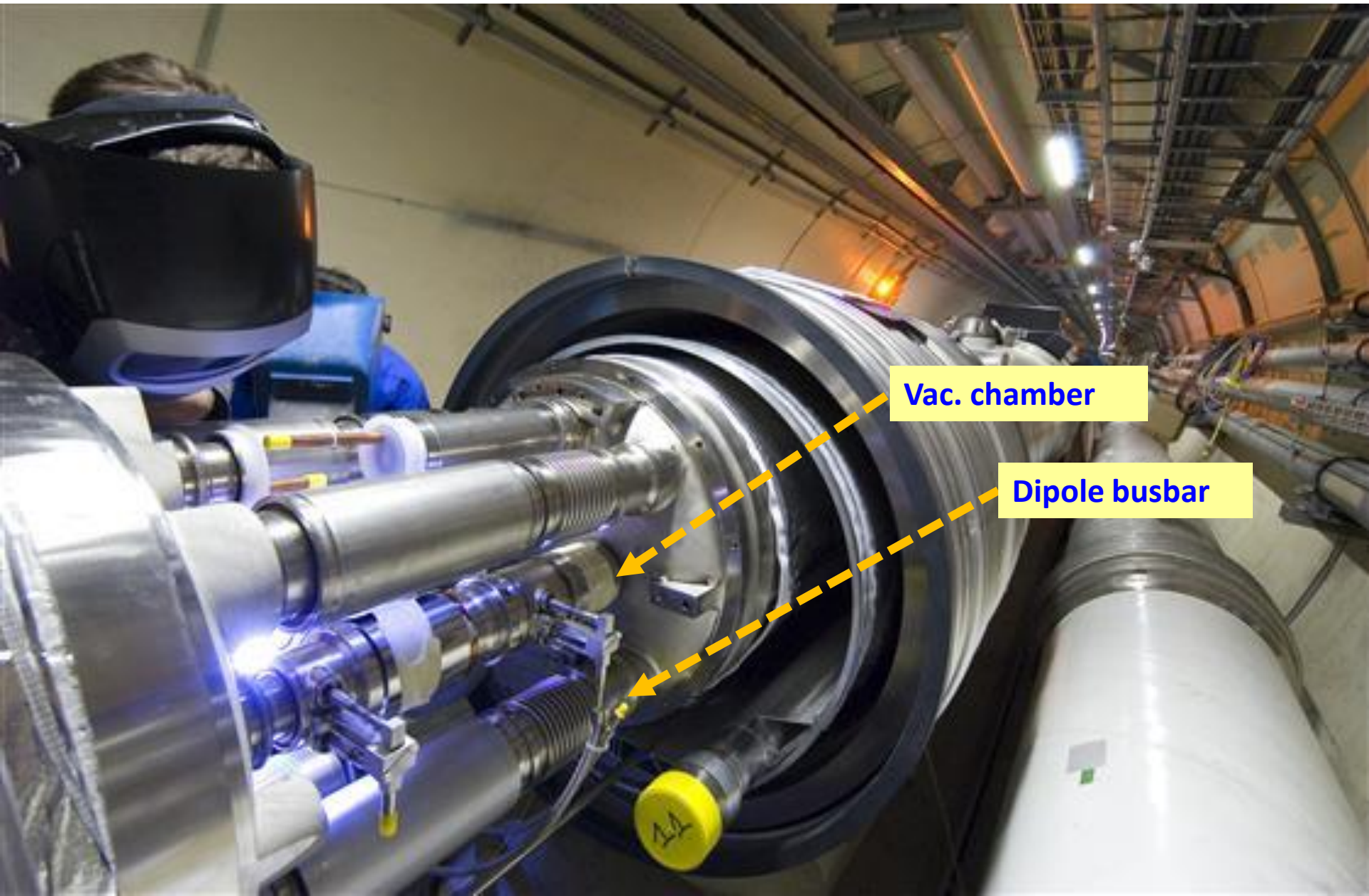

Vac. chamber

Dipole busbar

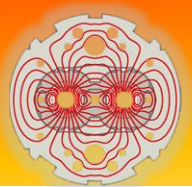

QQBI.27R3



Initial Run parameters were announced Friday

Schedule announced today

Initial run will be 200pb^{-1} starting September 2009

Energy will be 5TeV on 5TeV

I can easily scale the numbers for the luminosity (but I have not scaled for energy)

Process	Number of Events
W->ev	4,000,000
Z->ee	400,000
ttbar	160,000
bbar	100,000,000,000
Gluino gluino (m=1TeV)	200
Higgs 120GeV	8000

There are no efficiencies or branching ratios taken into account here

It is not a coincidence that one can discover this Higgs with this data set.

[Whats a femtobarn?](#)

Conclusions

- LHC will turn back on in 2009
- This will be a discovery machine.
 - I have touched on two possible discoveries
 - Dark Matter
 - Extra Dimensions
- I suspect though that the most interesting discoveries will those that have not been anticipated.

Units

- I am going to be using some units that are common in particle physics: barns, femtobarns, inverse femtobarns and so forth
- Its worth taking a moment to define them

Cross Sections

- Are measured in barns
- A barn is about the size of a Uranium nucleus
 10^{-24} cm^2
- A femtobarn is 10^{-15} of those so, 10^{-39} cm^2



Luminosity

- We measure how much beam has been delivered in inverse barns
- That way number of events=(cross section) \times (Luminosity) \times (efficiency)
- At nominal luminosity the LHC will deliver 20fb^{-1} per year

[Return](#)