



Environmental Institute of Houston

THE ENVIRONMENTAL INSTITUTE OF HOUSTON 1995 ANNUAL REPORT



Environmental Institute of Houston

University of Houston Clear Lake
and the
University of Houston
Houston, Texas



Environmental Institute of Houston

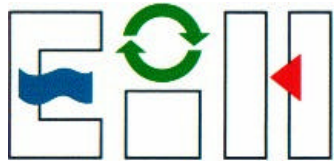
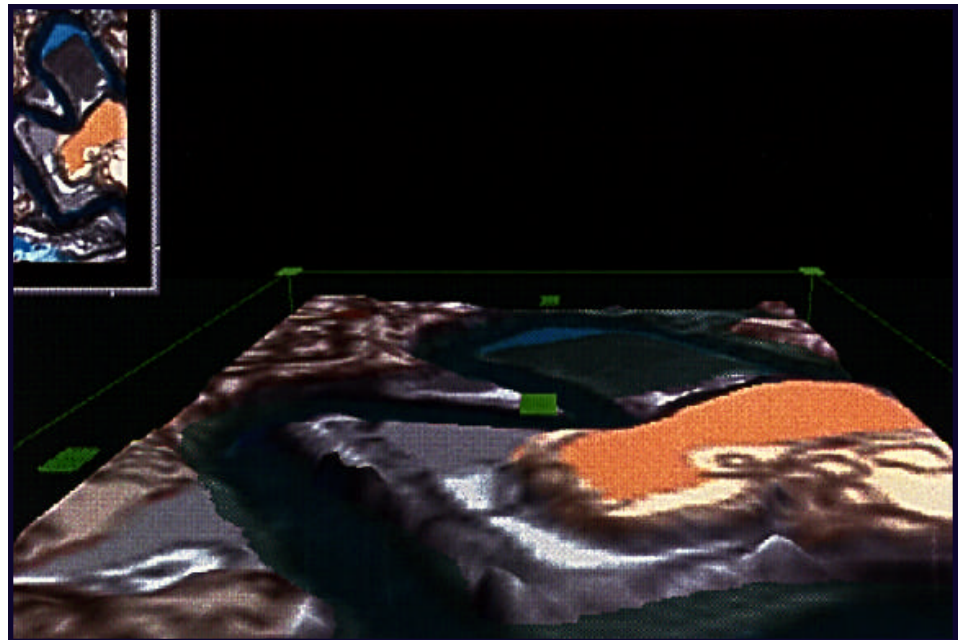

Environmental Institute of Houston



Environmental Institute of Houston

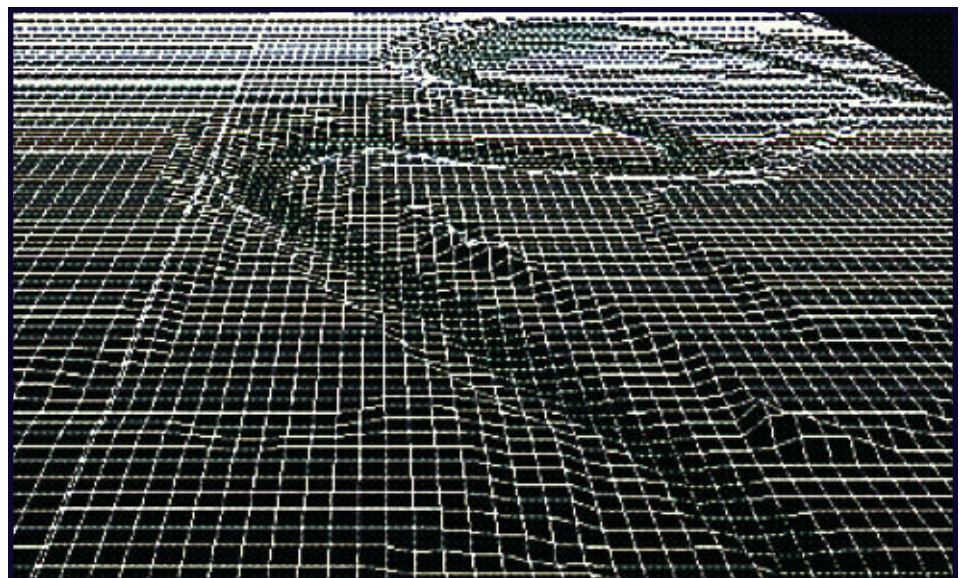

Environmental Institute of Houston



The Environmental Institute of Houston Advisory Board

The Cover

STUDENTS IN THE SCHOOL OF ARCHITECTURE have been introduced to interactive mapping of environmental phenomena by Jean-Marc Gauthier, Architect, D.P.L.G., Lecturer, and William Hartman, Architect, Design Studio, School of Architecture, UH (See report, p. 14).

Data for an "Ideal Map" (the cover design shows a section of Buffalo Bayou in Houston) is layered from a spreadsheet to a two-dimensional map, or pictured as a three-dimensional terrain in the computer, along with a texture and color legend that refers to intensities of luminance values. Each layer of the two-dimensional map is morphed individually and key-framed in an animation of x frames. The layers of each frame are flattened in one image, which becomes the resulting frame. This image is processed in three dimensions by scanning the luminance levels and assigning altitudes to each value according to the color legend.

The result is a colorful animation of y frames of terrains of layers of data that happen to exist simultaneously on the same territory with or without the same timing and at the same place, or not at the same place. Morphing each layer of data separately creates a protection for the integrity of each layer of data. In the same manner, each layer is key-framed separately according to its own time lapse. The resulting animation is a transformation of a three-dimensional terrain that can be fine-tuned with additional three-dimensional morphing point-by-point in order to get snapshots of intermediate deformations of the map for intervals of time not included in the original data spreadsheet.

Three-dimensional morphing can be pushed one step further with particle animation. This technique transforms the animation of static deformations of a terrain into a dynamic flux of particles of various shapes and sizes, suspended in various places in space. The reading of that picture is far superior to a photo of the terrain, itself, and helps to visualize more relationships.

EIH
UHCL/UH

C. S. 'Buddy' Barnes
E.B.I.
Gigi Bear
Shell Development, West Hollow
Steve Bost
Exxon Co., U.S.A.
Dick Brown
Gulf Coast Waste Disposal Authority
M. A. Bengtson
Galveston Bay National Estuary Program
Barbara Carroll
Exxon Chemical
Bonnie Cockrell
A Bonnie Company
Fran Coppinger
Keep Texas Beautiful
Ted Eubanks
Fermata, Inc.
Ed Feith
The Light Company
Marilu Hastings
Environmental Defense Fund
Jim Kachtick
Occidental Chemical Corporation
George Regmund
Armand Bayou Nature Center
David Schmidly
Texas A&M University at Galveston
Linda Shead
Galveston Bay Foundation
Diane Sheridan
League of Women Voters
Mike Terraso
Enron Corporation
Dale Thorum
Hoechst-Celanese Chemical Company

UH & UHCL Faculty Advisor Board Members

Beth Beloff, I.C.E.M., UH
Guy Cameron, Biology, UH
Dennis Clifford, Environmental Engineering, UH
Bob Heath, Communications, UH
Peter Bowman, Environmental Management, UHCL
Raj Chhikara, Statistics, UHCL
Cindy Howard, Biology, UHCL
Bob Jones, Education, UHCL

Contributors

ARCO Chemical
East Harris County Manufacturers
Association
Friendswood Development Company
Gulf Coast Waste Disposal Authority
Houston Lighting and Power
John O'Quinn Law Firm
Lockheed Aerospace
McDonnell Douglas Corporation
Texaco Foundation

Individual Contributors

Wilhelmina "Beth" Morian
Fran Coppinger



**University of Houston
Clear Lake**

William A. Staples, Ph.D.
President
Edward J. Hayes, Ph.D.
Senior Vice President and Provost

University of Houston

Glenn Goerke, Ph.D.
President
John Ivancevich, Ph.D.
Executive Vice President and Provost
Arthur Vailas, Ph.D.
Vice-Provost for Research and Graduate Studies

**The Environmental Institute
of Houston**

Jim Lester, Ph.D.
Director
Glenn D. Aumann, Ph.D.
Co-Director
Tom Maloney
Assistant Director

**University of Houston
Clear Lake**

Houston, Texas 77058-1098
Phone: (713) 283-3950
FAX: (713) 283-3044
Internet: Lester@cl4.cl.uh.edu

University of Houston
Houston, Texas 77204-5505
Phone: (713) 743-9130
FAX: (713) 743-9134
http://www.eih.uh.edu

March 1996

Table of Contents

Director’s Message 1

The Land and Its Waterways

The Changed Environment of the Lower Brazos River Valley of Texas 2

A Process To Develop a Rural Sustainable Development Plan for the Caddo Lake Watershed in Jefferson, Texas 3

Geophysical Surveys in Galveston County To Investigate the Geometry of Near Surface Geological Units 4

Sediments as Potential Pathway for Contaminants in Trinity Bay 5

Pollution Prevention

A High Temperature Pathway for Microbiological Desulfurization Deposition of Inorganic Thin Films for Energy Conserving Applications 6

Pollution Prevention by Bioconversion of Industrial Waste Materials to Biosurfactants 7

Vertical Fluid Migration in Shallow Fluvial Sediments: Chemical Contamination of the U.S. Gulf Coast 8

Reduced Atmospheric Pollution through Optimized Traffic Signal Control 9

Biodiversity

Effects of Habitat Fragmentation on Biodiversity: Implications for Management of Wetlands in Texas 10

A Model System for Understanding Evolution of Neotropical Biodiversity 11

Management and Monitoring

An Energy Design Assistance Center at the Modeling and Simulation Laboratory 13

Computer Visualization of Environmental Phenomena and Urban Systems along Houston Bayous..... 14

Perception of “Dread” in Two Communities Near Toxic Sites..... 15

Historical Analysis of Precipitation in the Tropics from Oxygen Isotopic Analysis from “Soda Straw” Cave Deposits..... 16

The Use of Stable RNAs in Environmental Monitoring..... 17

Bioluminescent Reporters for Detection of Mutagenic and Carcinogenic Environmental Contaminants..... 19

EVAL95: A Computer Program for Evaluating Environmental Policy 20

The Environment and the Classroom

Faculty Workshops To Develop Environmental Modules for Business 21

Project Environmental Awareness: A Curriculum Plan for Primary Grades 22

Environmental Education..... 22

Principal Investigators

Contents

EIH
UH/UHCL

The Texas Gulf Coast is one of the finest wildlife preserves in the world. It is a major tourist attraction. Its biggest attraction is the richest array of free-flying birdlife in the continental United States. This generation must preserve this heritage for our children and their children and their children's children.

Photos by Bill Ashley

iv, 2, 19, 20, 21, 22, inside back cover



• EIH

University of Houston Clear
Lake / University of Houston
Houston, Texas

Director's Message

This annual report marks the end of the first biennium of state funding for the institute. There are two important roles that describe most of the institute's activities. One is the support for new research projects through direct funding or identification of opportunities. The second is providing coordination or expertise for environmental activities to our environmental constituencies, such as government agencies and citizen groups. The primary function of this report is to document the value of projects supported in the first role, but EIH has gained many supporters around Texas through the second function.

As you will note after reading the research summaries, environmental researchers on the two campuses embody many strengths, but there are significant gaps in the expertise on the two campuses. Four areas of environmental concern emerge as emphases in this report: (1) the land and water of the state, (2) pollution from chemical processes, (3) environmental management and monitoring, and (4) the environment and the classroom. The strength and breadth of the principal investigators on these projects is very impressive. But one might ask why pollution is not a focus, or where are the studies of environmental policy? If we are to address the critical environmental issues facing this region, the environmental expertise among our faculty must grow in some important areas, such as atmospheric science and environmental policy studies.

The Environmental Institute of Houston has provided seed money to enable projects at their infancy to mature and injected supportive funding to ensure the completion of projects. The effort of the faculty requires the full resources of their academic training, their ability to review the documentation with discernment, their capability, in most cases, to recruit enterprising students—and a plodding, methodical, unrelentless effort to conduct the field work.

Theron Garcia (UHCL) is studying the capability of clay minerals to cycle common pollutants such as metals and pesticides. Her seminal research will shed new light on the interactions of clays, organic material, and pollutants in the Galveston Bay System. To consolidate information about the Brazoria County region of the Texas Gulf Coast, a team of researchers—Joan Few, Karen Elliott Fustes, and Justin Taliaferro (UHCL)—have devoted themselves to compiling a database of records from diverse agencies, including the Army Corps of Engineers at Galveston, the Brazoria County Parks Department, the Brazos River Port Authority, the Texas Agricultural Extension Service at Brazoria County, and the historical museums of Brazoria County and Columbia.

Regina Capuano (UH) has monitored the Texas Coastal Plain to discover high concentra-



**Dr. Jim Lester, Director
The Environmental Institute of Houston**

tions of chloride in shallow ground water, caused largely by transpiration in relatively large (200 mg/L) increases in chloride in shallow (2 m deep) pore water during periods of saturation. She and her students conducted a range of tests including the study of vertical hydraulic conductivity and changes in fluid composition in clay-rich sediments over a depth range from 3 to 23 m.

Genetically-engineered microorganisms have been heralded as a panacea for applications in oil-spill disposal, waste degradation, and pest control. We have yet to learn about the effects of the dispersal of these microorganisms into the soil, which is the purpose of George Fox's (UH) use of stable RNAs in environmental monitoring.

Cumaraswamy Vipulanandan (UH) has undertaken a project of direct interest to the consumer and the restaurateur. He is investigating methods of producing biosurfactants (usable products) from wastewater containing vegetable oil and olive oil. And John Watson (UH) seeks to reduce additional exhaust fumes emitted by stop-and-go traffic at faulty traffic lights.

Guy Cameron's (UH) major concern is the fragmentation of natural habitats. This problem threatens biodiversity. Natural habitats are being divided into progressively smaller patches, isolating areas from their original environs. The results include faunal collapse, invasion of exotics, and the alteration and disruption of ecosystem processes.

In education, EIH is funding at both the elementary level and the professional level. Carolyn Black and Margaret Hill (UHCL) have devoted themselves to improving the science curriculum of the primary grades in the Clear Lake Independent School District, with programs designed for the visitation of teachers to environmentally-controlled sites. Faculty members from all four UH campuses are designing business courses with environmentally-oriented syllabi, such as Accounting 3337, "Environmental Considerations in Cost Accounting," a burgeoning field, in itself.

These are but a few of the projects sponsored by EIH this past year. We invite new proposals that may offer expectations of preserving and improving the environment.

Many people and organizations are using EIH as a gateway to the environmental programs and information of UH Clear Lake and UH. We are coordinating several projects in environmental education and are actively participating in community environmental projects, such as Trash Bash, Earth Day celebrations, and Recycle Day. EIH and the universities are committed to our region. Our faculty have given their time to numerous community environmental projects, the largest effort of the last year being Houston Environmental Foresight. This was a comparative environmental risk study of the eight-county region around Houston.

I am indebted to the faculty, staff and students of UH Clear Lake and UH who have made EIH a success. Members of the community, especially the EIH Advisory Board, have given their time and support to the effort. They are recognized in this report. It is also important to recognize the companies who provided supplemental funding for EIH during the period covered by this report. I am grateful to all of you who have contributed to our efforts.

Thanks,
Jim Lester

The Director's Message

EIH • 1

UH/UHCL

The Changed Environment of the Lower Brazos River Valley of Texas



Riparian Forest woodpecker habitat in the Brazos River Valley.

MANY TECHNICAL AND HISTORIC records exist to detail environmental change in the Brazoria County region of the Texas Gulf Coast. This project was designed to computerize existing information to encourage and facilitate studies of the changing environment. The following agencies and institutions were surveyed and their documents entered in the data base:

Army Corps of Engineers: Galveston: All permits issued in Brazoria County are listed by waterway, and are itemized by permit number, name, and brief description.

Brazoria County Historical Museum: Includes archival list, UH, research inventory.

Freeport *Facts* Newspaper collection: Library map case, index, newspaper inventory, including uncatalogued newspapers.

Brazoria County Parks Department: All records about parks development including environmental impact statements.

Brazos River Port Authority: All records (last five years) of Authority activity.

Columbia Historical Museum: Inventory of photo collection, maps, books, newspapers and documents, including extensive documents (ranch records) from the Estate of Kittie Nash Groce.

Lake Jackson Historical Association: (Lake Jackson, Texas): Records documenting the establishment of Dow Chemical Co. in Brazoria County, photo collection, aerial photo collection, local history collection.

Texas Agricultural Extension Service: Brazoria County Archives includes records of demonstrations and educational activities beneficial to the lives and practices of those in rural areas since 1943. Major topics include cotton (prior to 1950), rice, grain, sorghum, soil A types, crops yields, farming and ranching methods, demonstrations given on cattle, pecans, soybeans, and pest control. Since 1978, records show more emphasis on long range planning and identification of issues, which include whole family issues, land use, pest control, family problems, nutrition, wellness, youth in crisis, *etc.* Brazoria County Fair records from 1960 until present are included. Annual catalogs detail the participants of the fair, crops, crafts, FFA, Girls 4H, home economics demonstrations and livestock.

USDA Agricultural Stabilization and Conservation Service, Brazoria County: All records (last five years) of commodity programs, commodity purchases and donations in Brazoria County, Conservation Reserve

Program, Agricultural Conservation Program, Disaster and Emergency Assistance.

USDA Natural Resources Conservation Service, Brazoria and Galveston Counties: Individual conservation plan records for landowners in Brazoria County; Area photographs for the year 1938, '39, '52, '58, '65, '74, '76, '83, and infrared in 1989. Records on the Bar X Levee Project; Bailey's Prairie Drainage Project; Bastrop Bayou Watershed Project; Conservation Tour; Irrigation Efficiency Evaluation; Irrigation Monitoring; Chocolate Bayou Watershed Project; Ecological Sciences and Technology Soil Range Correlation; Irrigation Permits; Land Judging Contest; Management Program for Agriculture and Silviculture, Nonpoint Source Water Pollution in Texas.

U. S. Fish and Wildlife Service, Angleton: Acreage under their jurisdiction:

Brazoria NWR 43,388.41 acres

San Bernard NWR 27,414.00 acres

Big Boggy NWR 4,526.05 acres

Documents in inventory include maps and aerial photos, reports, and documents listed by topic.

Varner Hogg State Park: Inventory of historical background materials and documents, cultural materials, natural information and storm tracking program.

The scope of information on Brazoria County is extensive but fragmented. Agencies and museums do not know what materials they possess in their archives and collections or the research value of their documents. There is a total lack of communication between all repositories in the County; computer formats are incompatible or totally lacking. Varner Hogg State Park has one of the best collections, but personnel can not read their own inventory on the computer. The state has itemized its inventory, but authorities have not provided the computers or software to utilize this resource. Efforts under a grant provided by the Environmental Institute of Houston to enable the assembling of research materials should assist all agencies and museums with research and encourage new environmental research in the area.

The final phase of this grant is formatting existing information into a home page on-line data base.

--Joan Few, M.S., Karen Elliott Fustes and Justin Taliaferro, Human Sciences and Humanities, UHCL

The Land and Its Waterways

2 • EIH

UHCL/UH

BY CREATING A PROCESS TO develop environments that are sustainable, we respect the history and the ecology of a region and add to it or build upon it, rather than replace or destroy it. In many rural areas, such as the Caddo Lake Watershed in far northeast Texas and the town of Jefferson, homes and farms have stayed in families for generations. Buildings have been rehabilitated over decades to new and alternative uses. Today, new structures—planned and designed—can be constructed from ecologically-sound design concepts and built from environmentally-responsible materials.

Resource-conserving planning concepts for sustainability are being created for the Caddo Lake Watershed by the Center for Urban Ecology that conserve energy, avoid the use of toxic materials, reduce the need for water, establish environmentally sensitive wastewater management technology, and create wildlife habitat.

The overriding premise of this sustainable design study was the creation of community. Sustainability is not simply the creation of ecologically appropriate structures and cities; it is, more important, about creating places that are unique, that are distinct places that can express man's habitation and his interconnectivity with all people, things, and the environment.

At Jefferson, Texas, there is a unique opportunity for the Center of Urban Ecology to set in motion a series of environmentally significant planning initiatives, initiatives that will help focus the community and galvanize the region. Jefferson, like many rural communities in America, has lost its closeness with the environment. From the dramatic alteration of its waterways to the denuding of its forest and fields, the natural order of the region has changed significantly. As the community struggles to sustain itself, there exists the opportunity for the University of Houston to help reestablish an ecological balance that can be a demonstrated model for communities like

A Process To Develop a Rural Sustainable Development Plan for the Caddo Lake Watershed in Jefferson, Texas

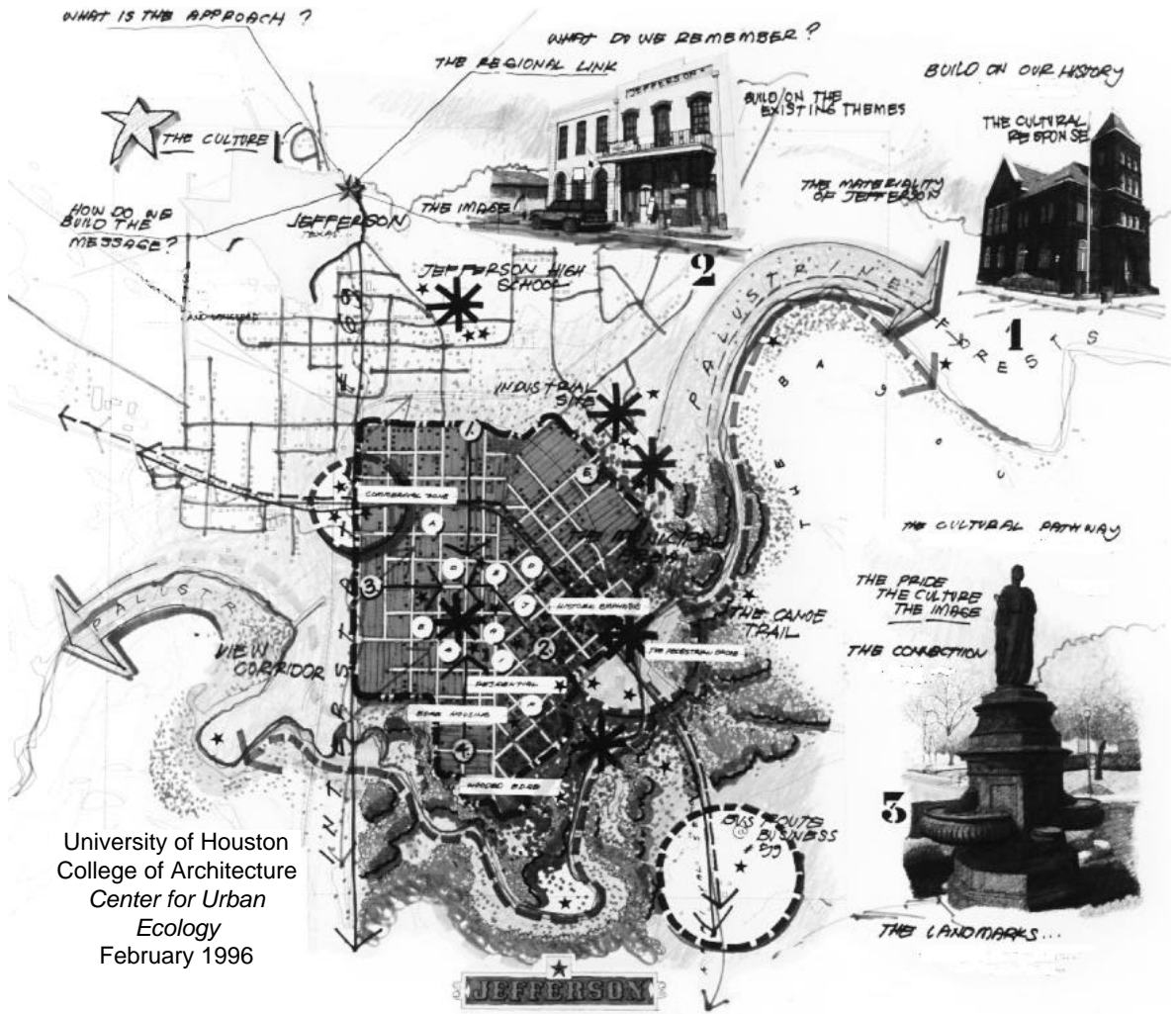

University of Houston
College of Architecture
Center for Urban Ecology
February 1996

Jefferson across the nation.

The Center for Urban Ecology expects to support a series of projects intended to conserve the environmental diversity of the region. It seeks to establish pioneer programs in environmental education that can demonstrate environmental stewardship. It will assist in the creation of a regional initiative on the environment to increase public knowledge of responsible environmental management based on practical suitability.

The Center for Urban Ecology has sought the expertise of the following partners:
U. S. Congressman Jim Chapman
U. S. Army Corps of Engineers, Fort Worth District
Bureau of Reclamation, Department of the Interior
National Biological Service, Southern Science Center
Texas Parks and Wildlife Department

U. S. Fish and Wildlife Service
Cypress Valley Alliance

--Lewis T. May, ASLA, Center for Urban Ecology, College of Architecture, UH

The Land and Its Waterways

EH • 3

UH/UHCL

Geophysical Surveys in Galveston County To Investigate the Geometry of Near Surface Geological Units

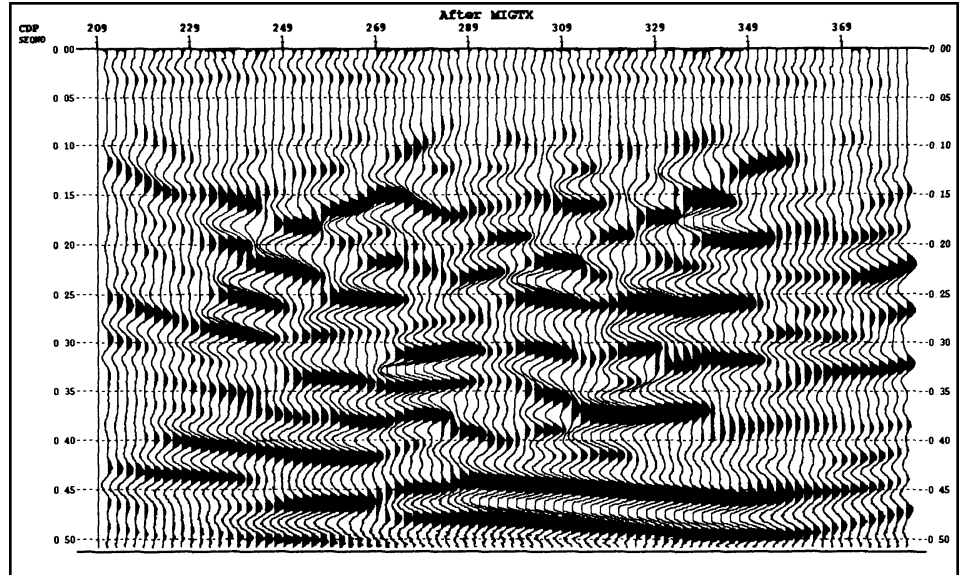

Geophysicists conducted an aerial conductivity survey followed by GPR, a ground penetrating radar survey, and a shear-wave seismic reflection survey.

AT A SITE ON THE WESTERN EDGE OF THE UH CoastalCenter, Allied Geophysical Laboratories conducted three geophysical surveys to investigate the geometry of near surface geological units. These three geophysical surveys were chosen to provide complementary information about the subsurface.

The first survey performed was an aerial electrical conductivity survey done in the vicinity of Dr. Regina Capuano's piezometer nests. The site was found to have an average conductivity of about 90 milliSiemens/meter, with variations of about ± 15 milliSiemens/meter. The instrument used is sensitive primarily to conductivity variations in the upper 12 feet of the subsurface. The presence of metallic pipes in the piezometer nests had no apparent effect on the conductivity measurements. This was not surprising; the presence of vertical conducting bodies would not be expected to greatly affect the horizontal conductivity.

Following the conductivity survey, both a ground penetrating radar survey (GPR) and a shear-wave seismic reflection survey were performed. The GPR survey did not distinguish any subsurface units well, although the velocity of radio waves in the subsurface could be determined from the data.

Shear-wave seismic data produced much better results. One of the lines acquired is shown in the figure above, after the data processing steps of stacking and migration. Shear-waves are clearly able to detect the subsurface stratigraphy. Stratigraphic units appear as

Line from the UH Coastal Center ▲

coherent seismic events at a variety of two-way times. An especially interesting event occurs at about 0.45 seconds, appearing to be a very definite interface between two distinct units. This two-way time corresponds to a depth of about 100 feet.

This study suggests that shear-wave seismic data could be effectively used at the Coastal Center site to map geological units to a vertical resolution of better than 5 feet. The lateral resolution of bed terminations is about 5 to 10 feet. The shallowest useful data are at a depth of 20 feet. This makes the technique appropriate for mapping only those units whose depth exceeds 20 feet.

AGL Grants

John A. McDonald

"A real-time scour measurement instrument," North American Geotechnical, 1993-1995, \$75,000.

"Seismic determination of pile and drilled shaft depths of termination," Texas Higher Education Coordinating Board ARPPProgram. \$111,610 for 2 years. Submitted July 1995 [unfunded].

"Geophysical Detection of bridge pier scour," Texas ARP, 1996-1997, \$183,205 [unfunded].

--Dan Ebrom, Ph.D., Research Assistant Professor, and John A. McDonald, Director, AGL, and Professor, Department of Geosciences, UH

The Land and Its Waterways

4 • EIH

UHCL/UH

Sediments as Potential Pathway for Contaminants in Trinity Bay

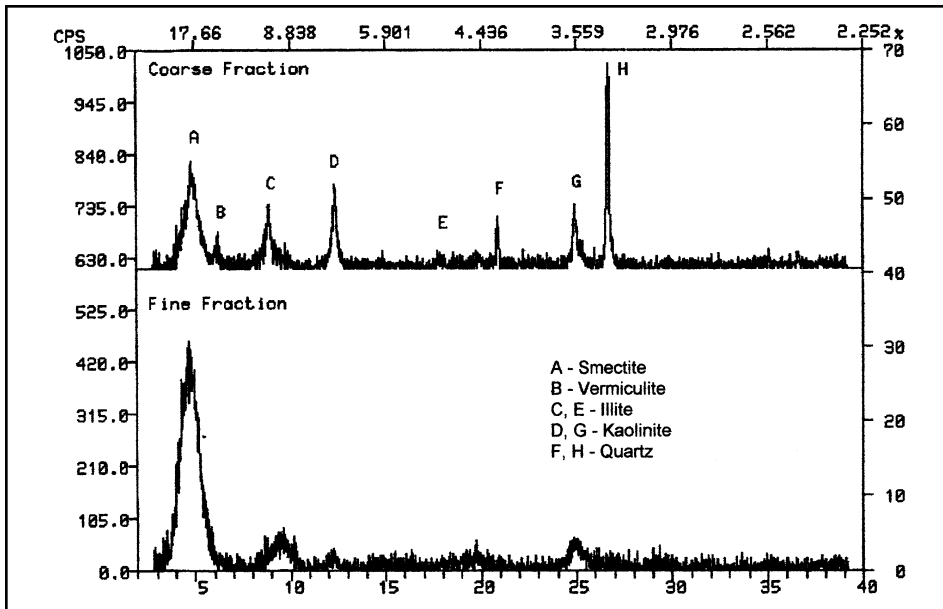

Figure 1. Representative diffractograms of coarse and fine Mg-saturated/Glycol-solvated clays (Sample GB006, Scintag Pad V X-Ray Diffractometer).

THE AFFINITY OF CLAY MINERALS FOR A variety of contaminants, notably metals and pesticides, has long been known. It is also known that the strength of this affinity varies with the mineralogy of the clay species. Among the clays, the smectites, due to their large surface area and extremely high cation exchange capacity (CEC), are of greatest interest in terms of cycling common contaminants such as metals and pesticides. While clay size particles are less than 2 microns in diameter, the smectite clays are 0.2 microns or less in size, thus explaining the extremely large surface area. Other clay species, due to their structure, size and CEC are much less reactive with contaminants.

This study sought to ascertain the particle size distribution and the mineralogy of the sediments along a transect from Houston Point to Smith Point. Two sites on the Trinity River Delta were also sampled to help determine the relationship between the sediments being transported by the Trinity River and the sediments found along the transect at the far reach of Trinity Bay.

The particle size distribution was determined by centrifuging the samples to separate grain sizes. Consistent with the sedimentary environment of the study, the coarsest sediments (sand size and coarse silt) were found in samples taken in the delta and near shore while fine par-

ticles (clay and fine silt size) dominated the remaining samples of the transect.

The mineralogy of the sediments was determined through X-Ray Diffraction (XRD) analysis of the clay sized sediments present in each sample, Fig. 1. As the diffractogram in Fig. 1 indicates, the coarser clay sized fraction contained clay minerals along with a lesser amount of quartz. The finer fraction was composed mainly of various clay minerals. It is likely that the samples also contained some shell material. However, any calcium carbonate present would have been digested during the preparation of the samples for XRD analysis, thus explaining the absence of the mineral calcium carbonate.

Estimates of the relative proportion of a given clay mineral in a sample can be made using the relative XRD peak intensities, Fig. 1. Using the relative peak intensity method, it appears that the total clay fraction is dominated by smectites followed by kaolinite, illite, mixed layer clays and vermiculite in descending order. Additional work will be required to more accurately quantify each clay mineral present. Since the greatest reactivity in clays is in the smectites, it can be concluded that the clay portion of the Trinity Bay sediments has the potential to be very active.

In addition to smectite clays, the sediments also contained two other constituents which are

important in the cycling of contaminants. Relatively large amounts (9-15 percent dry weight) of manganese dioxide, a mineral which is known to have a great capacity to adsorb heavy metals, were detected. The samples also contained approximately five percent organic material. Organic matter has a much higher CEC than even the smectite clays and a reactivity that is several orders of magnitude greater than smectites.

This study has shown that the major sedimentary components of the sampled sites in Trinity Bay are highly reactive materials that have a great potential to interact with various contaminants which may be present in the bay system. The smectite clays, manganese dioxides, and organic matter of the sediments combine to form an environment capable of exchanging many of the contaminants known to be present in the Galveston Bay Complex. Models which propose to describe pollutant cycling within the bay system must consider the role the bay sediments play in providing a pathway for various contaminants.

In February 1995, Al Roco, research assistant, presented a report on the research in progress to the Annual Soil Survey and Land Resource Workshop, Texas A&M.

--Theron D. Garcia, Ph.D., Associate Professor of Environmental Sciences, UHCL

The Land and Its Waterways

EH • 5

UH/UHCL

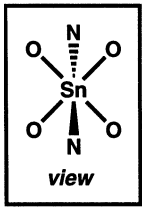

Figure 1. Thermal Ellipsoid Plot of $\text{Sn}(\text{OCH}(\text{CF}_3)_2)_4(\text{HNMe}_2)_2$ from a single crystal x-ray diffraction study.

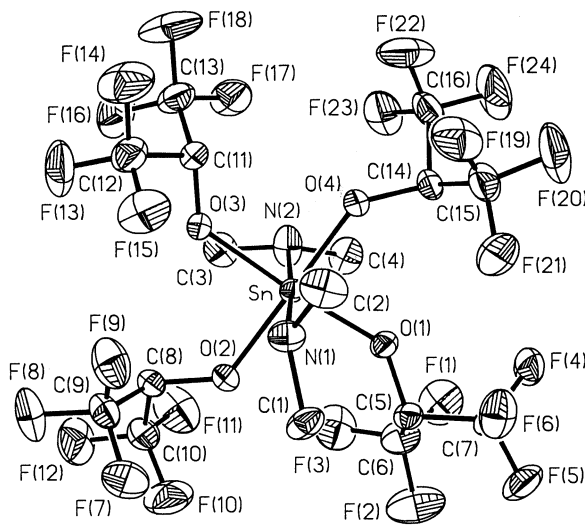
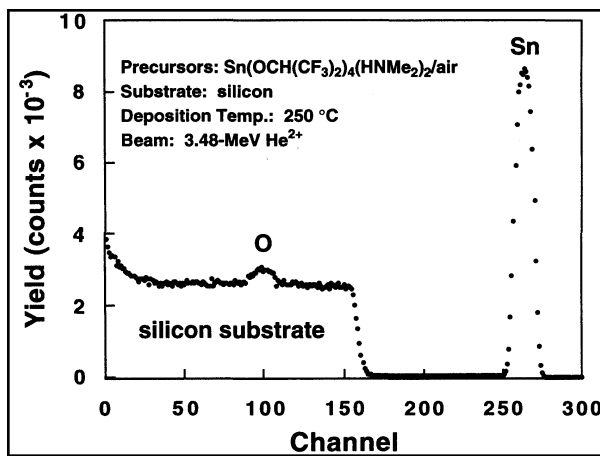

Figure 2. Backscattering spectrum of a $\text{SnO}_2:\text{F}$ film.



Deposition of Inorganic Thin Films for Energy Conserving Applications

ZINC (ZnO) AND TIN OXIDE (SnO_2) ARE highly transparent to visible light, yet they are good electrical conductors, especially when a small amount of fluorine has been added (“doping”). Because they have this unusual combination of properties, zinc and tin oxide thin films can be used as transparent electrodes in thin film solar cells.

The best technique for preparing zinc and tin oxide films for use in solar cell applications is metal-organic chemical vapor deposition (MOCVD). MOCVD methods currently used to deposit the oxides are inadequate, however, because the chemicals used to make the films (the “precursors”) are either difficult to handle on a large scale (ZnO) or they require deposition temperatures that are too high (SnO_2). The goal of our research is to deposit high quality zinc and tin oxide films at low substrate temperatures from new, relatively safe and easy-to-handle precursors.

We have successfully deposited ZnO thin films by atmospheric pressure MOCVD from oxygen and $[\text{EtZn}(\text{NEt}_2)]_2$, a compound we readily prepare from EtZnCl and LiNEt_2 . $[\text{EtZn}(\text{NEt}_2)]_2$ is a volatile liquid (boiling point 60°C at 10^{-2} mm Hg), an important characteristic of a good CVD precursor, and only moderately air sensitive, thus fitting our requirement of an easy-to-handle precursor. Films deposited at 300°C by atmospheric pressure MOCVD are crystalline as-deposited and show excellent transmittance in the visible region ($>85\%$ above 380 nm). We have also successfully deposited fluorine-doped tin oxide films using the new precursor $\text{Sn}(\text{OCH}(\text{CF}_3)_2)_4(\text{HNMe}_2)_2$. $\text{Sn}(\text{OCH}(\text{CF}_3)_2)_4(\text{HNMe}_2)_2$ and air give highly transparent films by low pressure MOCVD at substrate temperatures of $200\text{--}450^\circ\text{C}$ (Fig. 1). Backscattering and nuclear reaction analysis data indicate the films have stoichiometries of $\text{SnO}_{2.0}F_{0.005\text{--}0.03}$ (Fig. 2). Extensive characterization studies, including resistivity and Hall measurements, are under way so that we can better assess the feasibility of using our films in photovoltaic applications.

--David M. Hoffman, Ph.D., Professor, and Siegi Suh, graduate student, Department of Chemistry, UH

A High Temperature Pathway for Microbiological Desulfurization

OVER THE PAST TWO YEARS, GREAT strides have been made in microbiological desulfurization, although with a different twist than originally proposed. After screening numerous soil samples for natural isolates, we failed to obtain any thermostable bacteria with the appropriate high temperature pathway. However, we did obtain organisms

with the ability to degrade an alternate model compound, carbazole, which is a major source of NO_x release from the consumption of fossil fuels.

Our collaborators, Energy Biosystems, are in fact quite interested in work on this compound. Consequently, we have refocused our efforts by developing a system for genetic analysis of this bacterium and have identified genes which express the enzymes of this pathway by transposon mutagenesis. A set of mutant organisms has been created, and these are currently under study.

At present, we are concentrating our efforts on cloning and on characterizing these genes in greater detail.

--Michael Benedik, Ph.D., Associate Professor of Biophysical and Biochemical Sciences, UH

Pollution Prevention

6 • EIH

UHCL/UH

Pollution Prevention by Bioconversion of Industrial Waste Materials to Biosurfactants

BIOCONVERSION OF WASTE materials is considered to be of prime importance for the near future because of its favorable economics, low capital and energy cost, reduction in environmental pollution, and relative ease of operation. Producing biosurfactants (usable products) from industrial wastewaters is a viable option. Biosurfactants are surface active agents derived from biological sources which, like synthetic surfactants, exhibit characteristic physical and chemical properties.

The initial study was limited to batch reactors and the three substrates of molasses, used vegetable oil, and olive oil, representing food processing wastewaters as sole carbon source with the salt medium. UH researchers investigated the optimum conditions for producing biosurfactants under non-aseptic environment.

Culture: Activated sludge obtained from a wastewater treatment plant in Houston, Texas was the source of microorganisms. The activated sludge was first acclimated to the organic substrate over a seven-day period in a master culture reactor (MCR) in which the pH was maintained at 6.6 ± 0.1 using 1N NaOH. Whole broth from the MCR was used as the inoculum in the rest of the studies. The MCR was maintained as follows: 9/10ths of the contents of this reactor were removed each week and replaced with fresh nutrient salt medium and the necessary amount of organic substrate to give a final concentration (15 g/l or 20 g/l). The fermentation was conducted in 2-liter glass jars (1 liter working volume). To enhance oxygen transfer, the contents of the reactor were continuously stirred at 450 rpm.

Salt Media: The medium had the following composition (g/l): K_2HPO_4 , 5.0; KH_2PO_4 , 5.0; $MgSO_4$, 2.0; NaCl, 0.1; $NaNO_3$, 5.0; yeast extract (Sigma), 3.0, in 1000 ml of tap water. All chemicals were reagent grade unless specified otherwise.

Assays: Surface tension measurements (ST) were made using a Fisher Autotensiomat calibrated with distilled, deionized water (72 dynes/cm), acetone (21 dynes/cm), methanol (23 dynes/cm), and glycerol (64 dynes/cm).

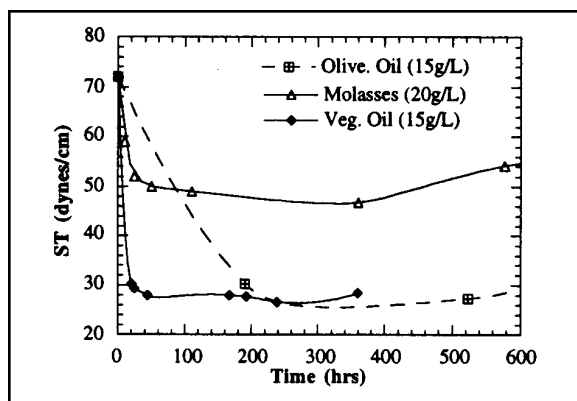

Figure 1. Surface tension of biosurfactants produced from 20 g/l molasses, 15 g/l used vegetable oil (used for frying food), and 15 g/l olive oil.

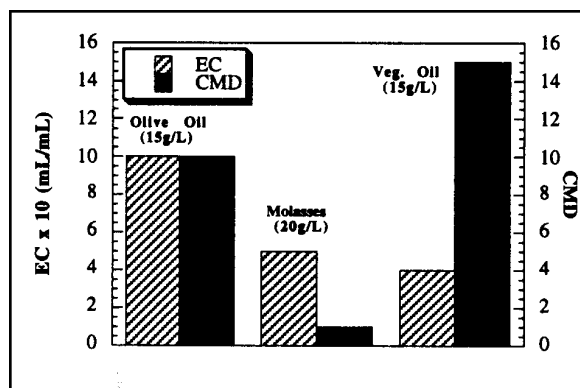

Figure 2. Emulsification capacity (EC) and critical micelle dilution (CMD) of biosurfactants reproduced from olive oil, molasses, and vegetable oil (current UH study).

The biosurfactant concentration is expressed in terms of critical micelle dilution (CMD), estimated by measuring the surface tension at varying dilutions (10- to 100-fold) of the sample. The dilution at which the surface tension abruptly begins to increase is termed the "critical micelle dilution," CMD, which is the factor by which the biosurfactant concentration exceeds the effective critical micelle concentration.

A practical measure of the utility of a biosurfactant solution is its ability to emulsify non-aqueous liquids. The emulsifying power of the test fluids was determined by the addition of *n*-hexadecane in 0.1 ml increments to 5 ml of the test fluid in a 15 ml test tube. The mixture was vortexed for 5 seconds after each addition and allowed to stand for 2 minutes. This procedure

was repeated until the emulsion collapsed. The volume of *n*-hexadecane added before the emulsion collapsed was defined as the emulsifying capacity (EC) of the test fluid.

Seed (5 mL) from the MCR was used as inoculum for subsequent batch tests using three substrates at various concentrations. Preliminary batch tests were continued for a period of 30 days in continuously stirred batch reactors with an agitation speed of approximately 200 rpm. The contents of the reactors were sampled at regular intervals for detailed characterization as discussed above.

Biosurfactant production from 20 g/l molasses, 15 g/l used vegetable oil (saved from frying food), and 15 g/l olive oil are summarized in Figs. 1 and 2. The production of biosurfactant appeared to be growth associated, for EC increased with the increase of biomass. The change in surface tension with time for the whole broth is shown in Fig. 1. Molasses broth showed a surface tension of 50 dynes/cm. The surface tension of the whole broth of used vegetable oil and olive oil dropped from around 70 dynes/cm to 30 dynes/cm in 20 and 200 hours, respectively. The emulsification capacity continued to increase over the entire period of the experiment for all three substrates. This contrast may be attributed to the biosurfactant's reaching its critical micelle concentration, beyond which constant surface tension is observed. Emulsification capacity continued to increase, however, with further biosurfactant accumulation. Highest CMD of 15 was obtained from the used vegetable oil reactor. Production and performance of biosurfactant were very much dependent on the type of organic substrate in the wastewater. The surface tension and, particularly, critical micelle dilution (CMD) achieved in our studies (mixed culture, non-aseptic condition) are generally comparable to those produced using pure cultures under more elaborate and expensive aseptic conditions.

Biosurfactants can be produced from water-soluble (molasses) and water-insoluble (used vegetable oil and olive oil) organic substrates in the wastewaters. Activated sludge was successfully used in producing biosurfactants from various organic substrates under nonaseptic conditions. Performance of the biosurfactants

(Continued on page 8.)

Pollution Prevention

EH • 7

UH/UHCL

Pollution Prevention by Bioconversion

(Continued from page 7.)

produced from representative wastewaters is comparable to the biosurfactants produced using pure cultures under aseptic conditions with expensive pure organic substrates. Based on the test results, proposals are being developed for external funding.

Presentations

Cumaraswamy Vipulanandan. "Effect of Clay and Biosurfactant on the Biodegradation of Toluene," *Geoenvironment 2000*, Sponsored by the American Society of Civil Engineers, New Orleans, Louisiana, Feb. 25, 1995.

--Cumaraswamy Vipulanandan, Ph.D., P.E., Associate Professor;
X. Ren, M.Sc., doctoral student,
Department of Civil Engineering, UH

Faculty direct graduate students in the study of vertical migration in shallow fluvial sediments of the Texas Coastal Plain.

Pollution Prevention

8 • EIH

UHCL/UH

Vertical Fluid Migration in Shallow Fluvial Sediments: Chemical Contamination of the U. S. Gulf Coast

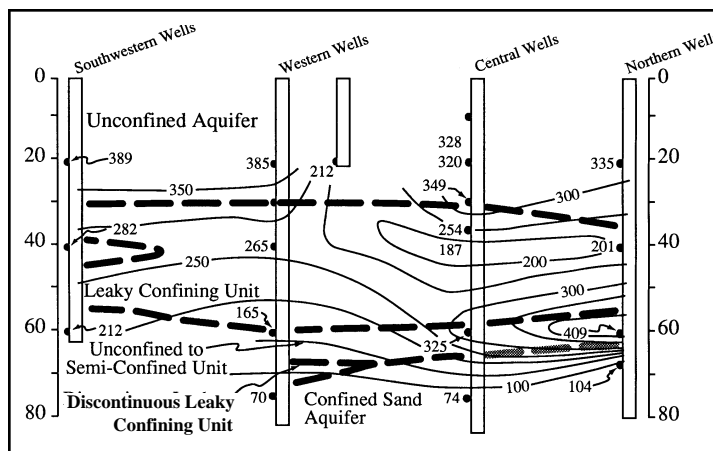

Cross section showing sulfate concentration (mg/L), Oct. 17, 1993.

GRADUATESTUDENTSAND I HAVE STUDIED several aspects of vertical migration in shallow fluvial sediments of the Texas Coastal Plain, which are summarized below.

(1) We tested the vertical hydraulic conductivity and changes in fluid composition in clay-rich sediments over a depth range from 3 to 23 m. The in-situ vertical hydraulic conductivity was found to range from 10^{-3} to 10^{-8} cm/sec and ion concentrations in the groundwater were found to vary up to 58 percent over this depth interval (Hinks and Capuano, 1995; Hinks, 1995).

(2) We conducted a dye tracer test to determine contaminant infiltration through the clay-rich vadose zone and found direct evidence of infiltration to a depth of 2.4 m within 28 days (Zou, 1995).

(3) We monitored changes in the stable isotope and chemical composition of shallow pore water through periods of saturated and unsaturated conditions and found that transpiration results in relatively large (200 mg/L) increases in chloride in shallow (2 m deep) pore water during periods of saturation. These increases are likely responsible for the relatively high concentrations of chloride in the shallow groundwater of this area (Mills and Capuano, 1995).

Publications

Hinks, A. W. and R. M. Capuano. "Spatial and temporal variations in the hydrogeologic properties of the Upper Beaumont Clay," In: R. Jensen, ed., *Proceedings of the 24th Water for Texas Conference*, Texas Water Development Board, 1995. Pp. 147-156. [Presented to the 24th Water for Texas Conference, Texas Water Development

Board, Austin, Texas, 1995.]

Mills, S. D. and R. M. Capuano. "Infiltration of rain water through clay-rich soil of the Beaumont Formation, Galveston County, Texas," In: R. Jensen ed., *Proceedings of the 24th Water for Texas Conference*, Texas Water Development Board, 1995. Pp. 161-170.

Capuano, R. M. and M. Johnson. "Geochemical reactions during biodegradation/vapor-extraction remediation of petroleum contamination in the vadose zone," *Ground Water* 33 (1995), in press.

--- and R. Z. Jan. "In situ hydraulic conductivity of clay and silty-clay fluvial-deltaic sediments," *Ground Water* 34 (1996), in press.

---, M. A. Siringan, R. Z. Jan, and P. Jurtshuk, Jr. "Enhanced activity of oligotrophic endogenous bacteria in clay-rich sediments by nutrient injection," *Geomicrobiology J.* 13 (1996), in press.

Theses

Hinks, A. H. "Spatial and temporal variations in the hydrogeology and hydrochemistry of a section of the Beaumont clay, Galveston County, Texas," Houston, M.S. thesis, 1995.

Zou, Z. Y. "Infiltration of dye tracers and nutrients into the vadose zone of the Upper Beaumont Formation," Houston, M.S. thesis, 1995.

Presentations

Capuano, R. M., R. Jan, M. A. Siringan, and P. Jurtshuk, Jr. "Bioremediation in shallow clay-silt sediments induced by nutrient injection: Resulting geochemical and microbiological reactions: Priorities in pollution prevention," Annual Gulf Coast Environmental Conference, Gulf Coast Hazardous Substance Research Center, Beaumont, Texas, 1994.

Siringan, M. A., R. Capuano, and P. Jurtshuk, Jr. "Bacterial analyses of ground water from a shallow clayey aquifer before and after nutrient addition," 94th General Mtg. of the American Society for Microbiology, 1994.

--Regina M. Capuano, Ph.D., Assistant Professor, Department of Geosciences, UH

Reduced Atmospheric Pollution through Optimized Traffic Signal Control

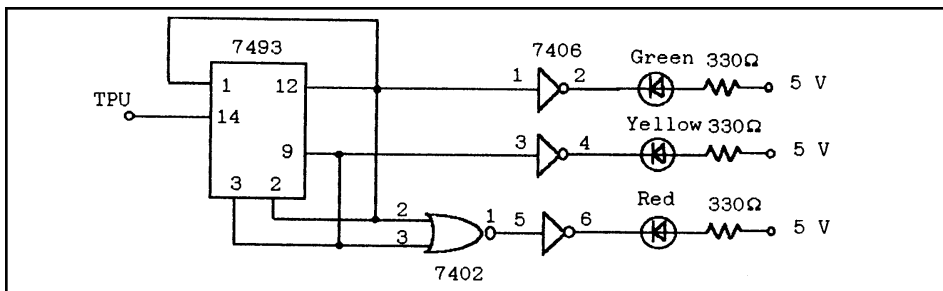

Figure 1. Digital logic circuit for activating traffic signal light isolators.

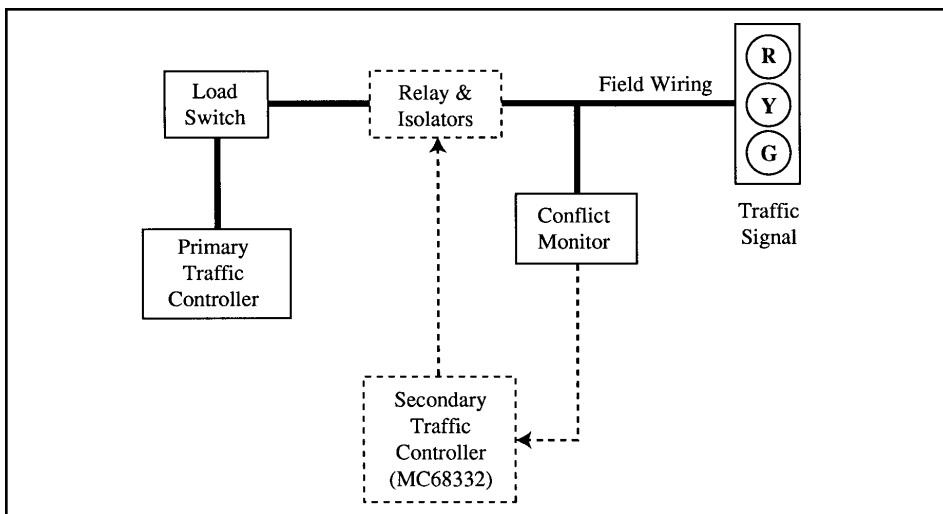

Figure 2. Integrating the secondary control unit in the existing traffic control box.

TRAFFIC SIGNAL LIGHTS ARE USUALLY forced into an all-red flashing sequence whenever the traffic controller fails. At major intersections, traffic congestion quickly develops since each vehicle must come to a stop before proceeding. It is possible to design a backup control system which would maintain traffic flow through the intersection during these failures, thus reducing atmospheric pollution from stalled vehicles.

Most traffic signal light controllers use a microprocessor-based keypad programmable control unit for scheduling traffic signal light phase timing plans each day of the year and for traffic flow conditions based on time-of-day and vehicle detection signals received from induction loop detectors. A conflict monitor detects the state of traffic signal lights to ensure that a dangerous signal conflict has not been initiated. Should a failure occur, the conflict monitor forces all traffic signal lights at an intersection to a flashing red sequence.

It is generally not cost-effective to include an

alternate traffic controller unit in most traffic signal light control boxes. However, it may be feasible to include a backup control system to maintain a default phase timing plan for the control of traffic signal lights at the intersection until maintenance personnel can arrive to repair the primary system.

Researchers selected a Motorola MC68332 microcontroller unit to perform the development work of the secondary control system. The MC68332 has 16 independent time processor units (TPUs) for maintaining the traffic signal light phase plans. The MC68332 develops the timing pulses required to activate the traffic signal lights through the digital circuit, shown in Fig. 1, which was developed to activate the red, green, and yellow traffic signal lights of a signal head through opto-isolators. Each time the logic circuit receives an active low pulse through input TPU, it activates the next signal state of the red-green-yellow sequence.

The circuit was designed to prevent a conflict from occurring in which more than one

red, green, or yellow signal light could be activated at the same time.

The MC68332 secondary traffic controller unit and support electronics can be integrated into an existing traffic signal light control box, as shown in Fig. 2, which includes the interface for one traffic signal. When the conflict monitor detects a signal light failure, it activates the MC68332 secondary traffic controller unit, which next provides the default traffic signal light phase plan for the intersection. The relay shown in Fig. 2 disconnects the Load Switch from the traffic signal light field wiring.

Opto-isolators receive control signals from the MC68332 secondary control system for supplying 110 VAC power to the field wiring designed to "drive" the intersection. In the meantime, the secondary control system uses its internal modem to notify maintenance personnel through a telephone line that it has been activated. Should the secondary control system fail, the conflict monitor will force the traffic signal lights again to the red flashing sequence. Programming of the MC68332 is under development.

Presentation

"Spread Spectrum SCADA Communication Systems for Energy Management," E&A'95 Symposium, 1995.

Research Proposal

"Optimizing SCADA Communication Systems for Energy Management," Energy Lab 1994-95, \$4200.

--John C. Watson, Ph.D., Visiting Assistant Professor, Department of Electrical/Electronics Technology, and Burt Marlow, IMSA Level III Signal Technician

Pollution Prevention

EI • 9

UH/UHCL

Effects of Habitat Fragmentation on Biodiversity: Implications for Management of Wetlands in Texas

Habitat fragmentation is among the most serious threats to biological diversity. By dividing natural habitat into progressively smaller patches, isolated from each other by habitats unlike the original, we see

- the collapse of faunal environments,
- the invasion of exotics, and
- the disruption of economic processes.

HABITAT FRAGMENTATION IS AMONG THE most serious of threats to biological diversity, as determined by a consensus of conservation biologists. "Fragmentation" has been defined as the division of natural habitat into progressively smaller patches of smaller total area isolated from each other by a matrix of habitats unlike the original. The effects of habitat fragmentation—faunal collapse, invasion of exotics, alteration/disruption of ecosystem processes—result from habitat loss and insularization, both of which contribute to a decline in biological diversity.

The effects of habitat fragmentation, like other ecological processes, are expected to vary among ecosystems. Coastal wetlands were selected as the research system for this study. Since their location coincides with population concentrations of humans, coastal wetlands are being rapidly fragmented and destroyed. Few studies have assessed the effect of such fragmentation upon wetland function or faunal composition. Fragmentation may adversely influence processes and productivity in wetlands. Wetlands serve an essential role in processes such as flood mitigation, storm abatement, erosion control, aquifer recharge, water quality improvement, and recreational activities. Wetlands are among the most productive ecosystems in the world, providing habitat for a wide diversity of waterfowl, shellfish, finfish, other game, fur-bearing species, and nongame species.

Small mammals (rodents) were selected as the focus of this research since they function as both predator and prey within the wetland ecosystem and for their ease of study. This research has three overall objectives :

- (1) to examine how species composition, relative abundance, and population demography of small mammals differ among fragments of wetland habitat,
- (2) to assess the relative contribution of species specific (*i.e.*, vagility, fecundity) and fragment characteristics (*i.e.*, size, edge, isolation) to the observed patterns, and
- (3) to ascertain whether invasion of fragments by exotic animals plays a role in formation of the observed patterns. Data unearthed in this study will help investigators determine the vulnerability of coastal wetlands to habitat fragmentation. Information will establish a database for use in management decisions.

Thirty habitat fragments (study sites) with varying physical and biogeographic characteristics were selected within the Galveston Island/West Bay area. GIS/GPS will be used to quantify size, degree of edge, connectivity, and proximity to other habitat areas of each study site under current conditions.

Small mammal communities are being monitored on each study site. Twice during the year in summer breeding and winter non-breeding seasons, small mammal populations are live-trapped to determine species composition at each of the study sites. In addition, small mammal populations are live-trapped monthly at six sites (at three small and three large fragments) to obtain detailed information on species composition, population density, sex ratio, age structure, distribution of body mass, reproductive state, survival, and movement.

Faunal collapse of rodents has not occurred widely in this wetland system. There are only two fragments where native species appear to be absent. One is the smallest fragment (~0.25 ha) which is highly isolated. The other, a moderately sized fragment, isolated for a long but unknown period of time, has been invaded by three exotic species of rodents (*Rattus*, *Mus*, and *Myocastor*).

Preliminary analyses of demographic data for the marsh rice rat (*Oryzomys palustris*), taken monthly (Aug. '94-May '95), indicate that population density per unit habitat area proved comparable in large and small fragments. However, relative density fluctuated dramatically among seasons in large fragments (~25/ha during autumn, 5/ha during winter and spring), but remained at a steady, intermediate level (~10/ha) in small fragments. Seasonal reproductive activity was synchronous among fragments (breed in summer and early autumn). Survival, however, was much higher in small (79 percent) than in large (15 percent) fragments, with little difference among seasons. Survival was measured as the number of times an individual was recaptured on a site. Thus, lower survival indicates higher mortality or emigration on large fragments.

Jan M. Williams-Rice, M.S. candidate, served as a research assistant on the project.

Grants

"Effect of habitat fragmentation on biodiversity: Implications for management of wetlands," Nature Conservancy, 1994-5, \$3,000.

Biodiversity

10 • EIH

UHCL/UH

A Model System for Understanding Evolution of Neotropical Biodiversity

"Effect of climate change on species distribution, diversity, and productivity in grass-forest habitats: A regional perspective," National Institute of Global Climate Change, Department of Energy, 1994-96. \$162,894.

"Effects of habitat fragmentation on biodiversity: Implications for management of wetlands in Texas," US Fish and Wildlife Service, 1995-97, \$12,164.

"Analysis of rare resources in Texas," Texas Natural Heritage Program, Texas Parks and Wildlife, 1995-96, \$25,000.

"Using remotely-sensed data to measure primary production," Research Fellows Program, Midwestern Regional Center, National Institute for Global Climate Change, 1995-96, \$3,500.

"Effect of habitat fragmentation on population processes in wetlands," Sigma Xi, \$650.

"Effects of climate change on wetland communities: subsidence zones as experimental systems" (with J. Webb, Texas A&M University), NSF, \$263,853. Submitted.

"Effect of subsidence on structure and function of saltmarshes in the Galveston Bay ecosystem" (with J. Webb and P. Levin, Texas A&M University), NSF \$451,653. Submitted.

Presentations

Cameron, G. N. "Effect of global climate change on biodiversity in Texas," Baylor University, Waco, 1995.

---. "Factors endangering native coastal prairie," Houston Area Research Consortium, 1995.

---. "Habitat fragmentation in wetlands," Environmental Institute of Houston, 1994.

---. "Impact of Chinese tallow," UH Clear Lake, 1995.

---. "Impact of exotic species on biodiversity of coastal prairie," University of Nevada, 1995.

Williams, J. and G. N. Cameron. "Analysis of rare resources in Texas," Texas Society of Mammalogists, 1995.

--Guy N. Cameron, Ph.D., Professor,
Department of Biology, UH

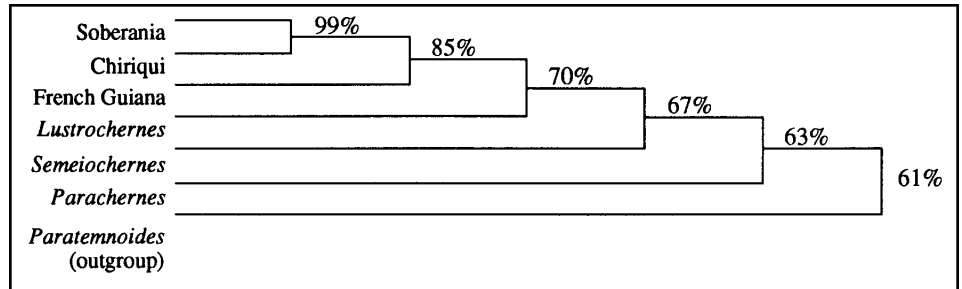

Figure 1. Phylogenetic relationships of three *C. Scorpioides* populations (Soberania & Chiriqui from Panama and French Guiana) and related genera based on mtDNA sequence from the cytochrome oxidase 1 gene. Numbers at nodes indicate percent sequence divergence.

THE HARLEQUIN BEETLE-RIDING PSEUDOScorpion, *Cordylorchernes scorpioides*, provides a model system for comprehensive investigation of neotropical diversification. In one of the first thorough studies of speciation in a neotropical arthropod, we have recently established the existence of cryptic species in what was previously thought to be a single arachnid species ranging from southern Mexico to northern Argentina (Zeh and Zeh, 1995). DNA fingerprinting, protein electrophoresis, morphometric discriminant function analysis, and reproductive compatibility experiments have demonstrated that populations of *C. scorpioides* from French Guiana and Panama are morphologically identical but genetically distinct and reproductively isolated at the postzygotic stage (Zeh and Zeh, 1994).

In this project, we have embarked on a wider ranging study in order to investigate the extent of cryptic speciation throughout the *C. scorpioides* complex. The research will ultimately encompass populations/cryptic species from Mexico, Panama, Ecuador, Venezuela, Trinidad, and French Guiana. The specific aim of this first year was to develop two new molecular tools, mitochondrial DNA (mtDNA) sequencing and microsatellite DNA allelic assays in order to identify genetically-distinct populations and to reconstruct patterns of speciation. The integration of information from mtDNA and microsatellites will provide a comprehensive picture of both historical and recent patterns of gene flow and population subdivi-

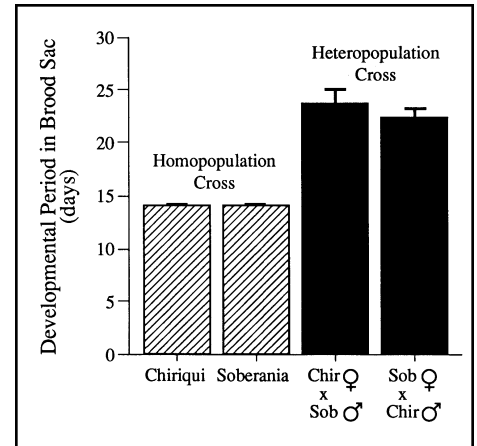

Figure 2. In females that hatch nymphs, embryonic development is prolonged from the normal 14 days to 23 or 24 days.

Biodiversity
EIH • 11
 UH/UHCL

(Continued on page 12.)

A Model System for Understanding Evolution of Neotropical Biodiversity

(Continued from page 11.)

sion. Although base substitutions in DNA sequence occur relatively slowly, the rate of sequence divergence in *mtDNA* is higher than in any other region. *mtDNA* sequence data will therefore be used to establish the phylogenetic relationships of populations on the scale of hundreds of thousands to millions of years.

Microsatellite alleles, which differ in number of tandem repeats of a simple sequence, evolve much more rapidly. They are thus powerful tools for resolving evolutionary relationships at a very fine scale. In addition, the high heterozygosity of microsatellite loci makes them extremely sensitive tools for determining kinship, detecting hybridization and inbreeding, and quantifying levels of contemporary gene flow.

Although this project will require two to three more years to complete, we have made considerable progress in this first year and have uncovered some intriguing initial results. These include:

- *Development of mtDNA primers which amplify a 500 bp region of the CO1 gene in both the pseudoscorpion and its dispersal agent, the harlequin beetle.* Tom Wilcox has now sequenced 200 bp of this region from three *C. scorioides* populations and several other pseudoscorpion species in related genera (Fig. 1). Populations from Panama and French Guiana, which were initially thought to represent a single species, show a staggering 15 percent sequence divergence. This level of divergence is equivalent to generic-level differences exhibited by many temperate bird species. Sequencing of the entire 500 bp region of this gene will be completed in September 1995 and will form the basis of

two manuscripts. By generating sequence data from both the pseudoscorpion and harlequin beetle, we will be able to examine the level of concordance in geographic patterns of population differentiation in the two species groups.

- *Collection of pseudoscorpions and harlequins from additional sites in Panama and from Trinidad.* Investigators will be sequencing the Trinidad samples for inclusion with the other populations. We are also in the process of establishing pseudoscorpion lines from Trinidad to examine reproductive compatibility with Panamanian populations. Preliminary findings indicate that the populations are compatible at the pre-zygotic stage, but are postzygotically incompatible.

Research carried out in collaboration with J. A. Zeh (Rice University) has shown that *C. scorioides* populations separated by only 350 miles (Chiriqui and Soberania) and 1 percent sequence divergence (see Fig. 1) exhibit significant levels of reproductive incompatibility at the postzygotic stage. Despite minimal divergence in DNA sequence, females in 50 percent of these heteropopulation crosses either fail to become gravid or abort embryos developing within the brood sac. In those females that do hatch nymphs, embryonic development is prolonged from the normal 14 days to 23 or 24 days (Fig. 2). These results may suggest that genomic imprinting, in which gene expression varies depending on whether genes are transmitted through sperm or eggs, may be responsible for an imbalance in paternal/maternal gene expression. Genomic imprinting is an intriguing evolutionary phenomenon which has only been demonstrated to occur in mammals but is expected to operate in any ovoviviparous or viviparous species (pseudoscorpions are ovoviviparous).

Lori Hugg has made significant progress toward developing microsatellite markers for *C. scorioides*. She successfully constructed a genomic library and has begun sequencing positive clones to identify regions suitable for PCR amplification of tandem repeat loci.

Publications

Zeh, D. W. and J. A. Zeh. "Sex *via* the substrate: Mating systems, sexual selection and speciation in pseudoscorpions," In *Social Competition and Cooperation, in Insects and Arachnids*. Vol. 1: *Evolution of Mating Systems*. Ed. J. C. Choe and B. J. Crespi.

Princeton: Princeton University Press, 1995. In press.

Zeh, D. W., and J. A. Zeh. "When morphology misleads: Interpopulation uniformity in sexual selection masks genetic divergence in harlequin beetle-riding pseudoscorpion populations," *Evolution* 48 (1994): 1168-82.

Grants

Hugg, L. "Molecular genetic analysis of cryptic species: Implications for neotropical diversity," Application to attend the Workshop on Molecular Evolution, Woods Hole, 1995, \$750.

Zeh D. W. and J. A. Zeh. "An experimental and phylogenetic analysis of cryptic species in the Neotropics," *National Geographic Society*, 1995, \$28,000.

Zeh, J. A. "Interpopulation crosses and post-copulatory sexual selection: A molecular genetic analysis," National Science Foundation, 1995, \$10,000.

Presentations

Hugg, L. "Mitochondrial DNA sequence analysis and microsatellite DNA allelic assays: Complementary tools in the phylogenetic analysis of cryptic species," Naos Molecular Systematics Lab informal seminar, Smithsonian Tropical Research Institute, Balboa Panama, 1995 (invited seminar).

Zeh, D. W. "Oscillating sexual selection and the male variability paradox," Department of Biological Sciences, University of Arkansas, Fayetteville, 1994 (invited seminar).

Zeh, D. W. "Sperm-storing females: Carriers of male variability in a heterogeneous environment," Symposium on Insect Mating Systems, International Ethological Conference, Honolulu, Hawaii, 1995.

Zeh, D. W. "When morphology misleads: Interpopulation uniformity in sexual selection masks genetic divergence in harlequin beetle-riding pseudoscorpion populations," Department of Entomology, University of Arizona, Tucson, 1995 (invited seminar).

Zeh, J. A. "Interpopulation crosses and post-copulatory sexual selection: A molecular genetic analysis," Department of Entomology, University of Arizona, Tucson, 1995 (invited seminar).

--David Zeh, Ph.D., Assistant Professor;
Lori Hugg, graduate research assistant;
Marcos Benitez, undergraduate work-study student, Department of Biology, UH

Biodiversity

12 • EIH

UHCL/UH

An Energy Design Assistance Center at the Modeling and Simulation Laboratory

THE SIMULATION AND MODELING Laboratory of the School of Architecture was established as a research and teaching facility in 1991. It serves as a technical interface to architectural design by providing relevant feedback on environmental performance factors such as sun, shade, daylighting, ventilation and acoustics through empirical measurements on scale models and by "what-if" computer performance simulation of buildings and their components.

Studies estimate that 80 percent or more of a building's energy characteristics are determined in the earliest design decisions of orientation, configuration, massing, and fenestration. The Simulation and Modeling Lab addresses a significant gap in the delivery of energy efficiency and environmental elegance in current building practice by interfacing with current design activities and assimilating them into architectural practice. The special challenge of operating as a professional design assistance center began in the summer of 1995.

Capabilities of the lab include the following scale model testing activities:

- Instrumented daylight measurements—Model tests are conducted in an 8 ft x 8 ft x 7 ft artificial sky with Licor photometers and PC host data acquisition to a Lotus 123V2.2 template. Protocols for identifying the direct, externally reflected, and internally reflected daylight components are utilized in order to identify potential improvements.
- Heliodyne sun machine—A dual tilting turn table is used to simulate solar penetration and shading performance on building or site elements.
- Fluid mapping table—Two dimensional (plan or section) air flow studies are performed on site or building scale profiles to analyze ventilation patterns.
- Wind tunnel—A 30 in. x 30 in. drawthrough wind tunnel is used to perform air flow tests with dry ice smoke.
- Acoustical modeling—Passive acoustics are studied by use of a ripple tank and wave generator or reflective surface scale models.

Model studies can be documented on video or still photography utilizing equipment maintained in the lab.

Computer simulation activities are centered around a set of specialized tools developed by Leonard Bachman and published with David

Thaddeus, assistant professor of architecture, as a set of spreadsheet templates for Lotus 123V2.3 and V5.0 for Windows, included in *Spreadsheets for Architects* (Van Nostrand Reinhold, May 1995). A collection of shareware and Prof. Bachman's privately collected items are also maintained in the laboratory.

A brochure describing the lab was produced during the summer 1995 and mailed to Houston architects and college alumni. A color printer and video capture board were added to the existing data acquisition 486 PC. The college provided additional support in the form of a phone line for the lab, plumbing and a sink for the fluid mapping table, and an ethernet line to the host PC.

Grant

"Implementation Project for Operation of a Professional Design Assistance Center," Texas Building Energy Institute, \$6522, pending.

Presentation

"Modeling and Simulation Lab," Houston Chapter of The American Institute of Architects Committee on the Environment with representatives of the Committee on Continuing Education, March 9, 1995.

--Leonard R. Bachman, AIA,
Assistant Professor,
Environmental Control
Systems; Janna Plentl,
research assistant,
School of
Architecture,
UH

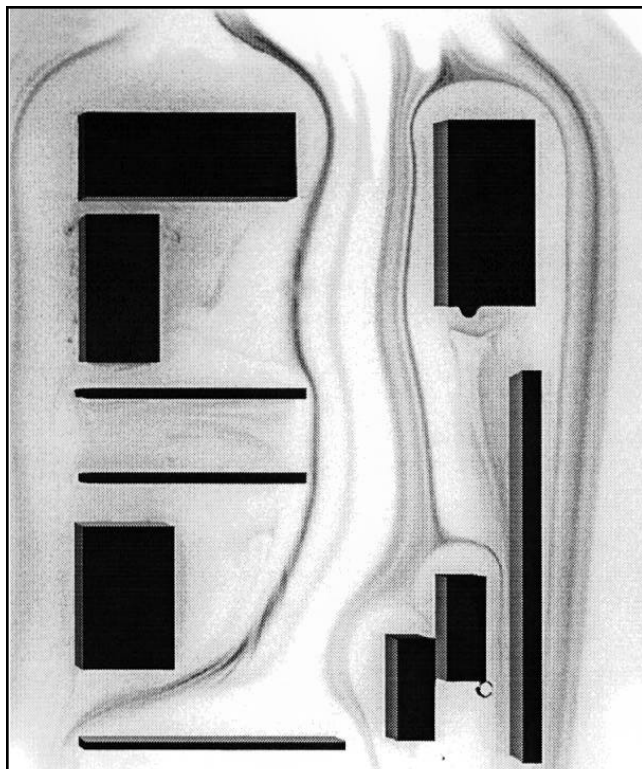

Air flow in 3-D models at the site illustrating buildings with scaled wind speed.

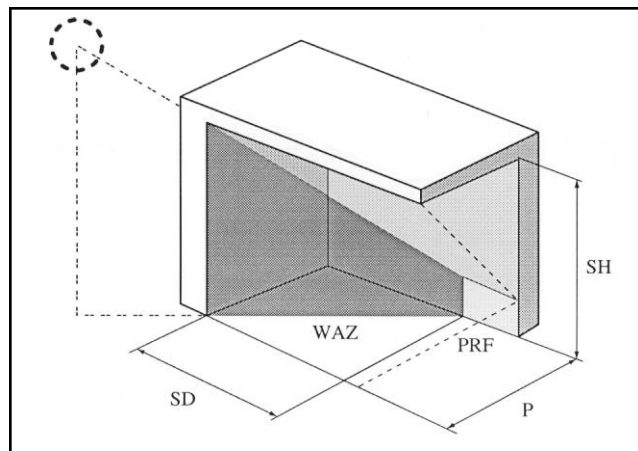

Heliodyne Sun Machine for scale model testing to determine shading efficiency and solar penetration.

Management and Monitoring

EIH • 13

UH/UHCL

Computer Visualization of Environmental Phenomena and Urban Systems along Houston Bayous

THE INTERACTIVE MAPPING OF environmental phenomena is an on-going design project that focuses on visual tools for animation and simulation of urban phenomena. The map is a hybrid group of features involving fast and inexpensive computer graphics, animation clips, communication procedures, data processing, and multimedia authoring.

The main question is how to represent data as a captivating visual interaction while keeping a sense of accuracy that could be checked at any time in any place with the value of any data. This adroit balance between scientific visualization and Walt Disney wizardry is the formula that will keep decision-makers interested in using maps of data as background for their deliberations.

The idea behind the map is to display three-dimensional data for decisions during the course of a meeting or during a virtual on-line interaction between several partners on the Internet. Participants can communicate over the map. They can input their own data or ask the computer to retrieve them from data banks from web sites. The interactive map can be used as a communication tool and also as an analytical tool; it lets people compare and measure the intersection of several fields of data.

An "Ideal" map can be created and simulated the same way. Its fields can be divided into sections in order to verify the meaning of its data and to understand the real-life strategies that could sustain the situation described by the Ideal map.

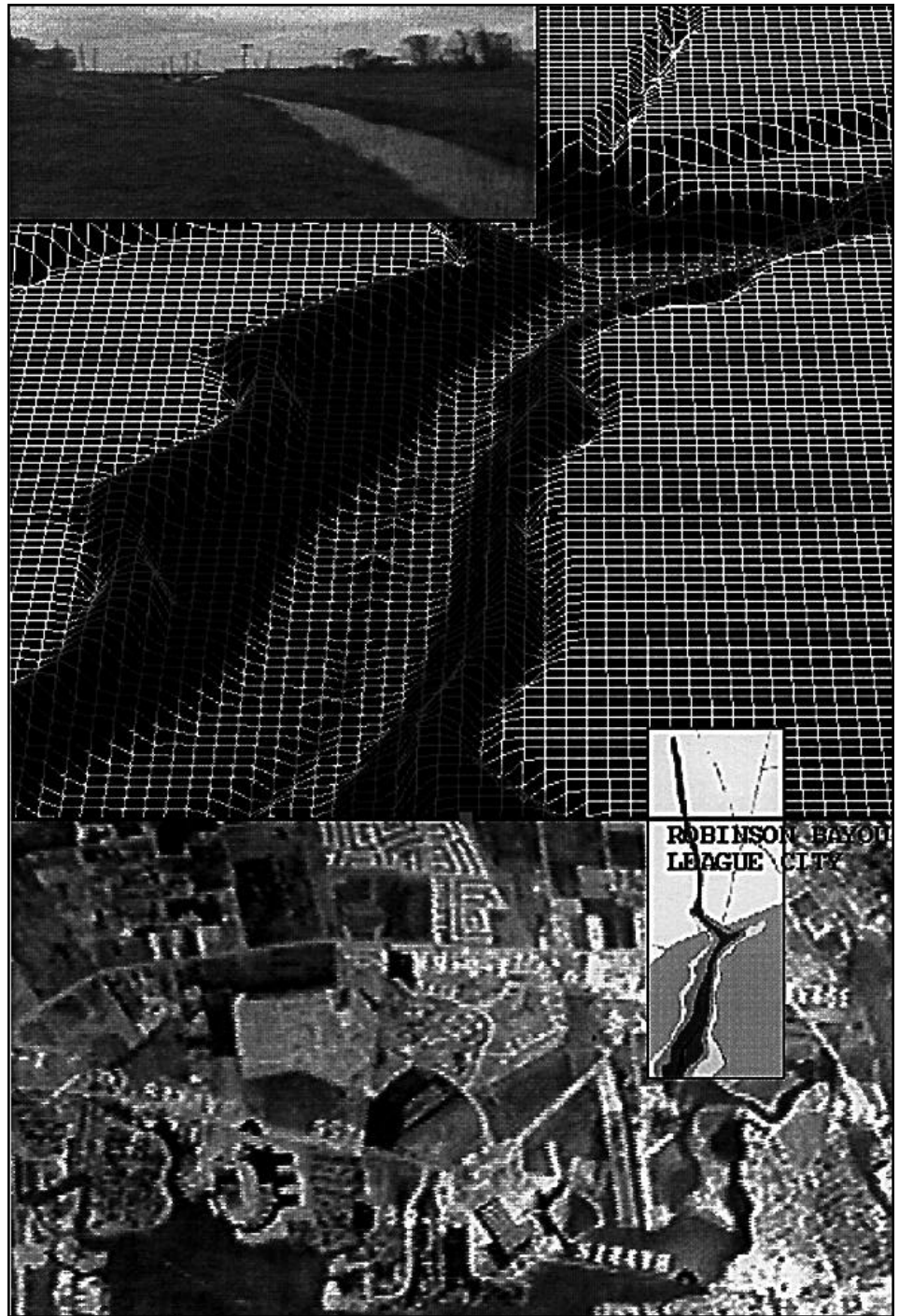

Photographic and digital views of Robinson Bayou in League City.

A single-semester electronic architectural studio provides architectural students with knowledge of multimedia and authoring systems in the context of urban planning strategies. In return, they become Beta users of the mapping project in their professional work.

In the studio, students use a stripped-down version of the interactive map running on a collection of inexpensive off-the-shelf software. Students are taught how to create paper documents ready for digital transformation. In this effort, they need to explore digital morphing and compositing as semantic tools in the language of computer graphics. The main difficulty is understanding the visualization of data

transformations through time and space. Users learn how to perceive the variation of phenomena in one place during an event in time—one example is the variation of water level in a street during a heavy rain. Users also simulate the daily repetition of the movement in space of an event—for example, the animation during 12 hours of the various locations of traffic peaks along Highway I-45, running north from Galveston, during a single weekday.

--Jean-Marc Gauthier, Architect, D.P.L.G., Lecturer, and William Hartman, Architect, Design Studio, School of Architecture, UH

Management and Monitoring

14 • EIH

UHCL/UH

THE SCHOOL OF Communication is studying environmental perceptions as part of an ongoing project in risk communication. This project is devoted to persons who live and work near chemical manufacturing and storage facilities who may "dread" their proximity to an industrial facility. Researchers are conducting a systematic and comprehensive review of the knowledge, perceptions, and communication patterns of area residents.

One key aspect of risk communication research is the effect that proximity has on a person's knowledge, perception, and communication patterns and preferences. The assumption is that people who live closer to chemical facilities suffer more "dread" about their proximity (*i.e.*, closeness) to the chemical manufacturing facilities than those who live further away.

This specific research project entailed using a professionally-conducted telephone survey to compare two groups of communities in the Houston area (250 respondents per group). One group (defined by three zip codes) consisted of residential neighborhoods near chemical manufacturing facilities; the second group (defined by three zip codes) was comprised of residential neighborhoods at least 20 miles from the Ship Channel.

Of particular interest was the effect of proximity on several variables:

- support for the industry,
- knowledge of the industry,
- uncertainty regarding the long-term effect of the industry,
- dread for health and safety effects of the industry,
- openness on the part of industry to the concerns of local residents, and
- the sense that the industry affects their self interest, knowledge, and trust (cognitive involvement).

The two communities did not show significant differences in terms of the amount of 'dread' experienced, trust for the industry, cognitive involvement regarding health and safety concerns, and the perception of openness or accessibility on the part of the industry. Differences showed up in their uncertainty and support of neighboring industry. People who lived further from an industry were more uncertain about its long-term effects, whereas people who lived closer to the industry voiced more support for the facilities.

Findings indicate that respondents in both communications have a low sense of trust in statements made by industry representatives and question the commitment of the industry to

Perception of "Dread" in Two Communities Near Toxic Sites

protect the health and safety of residents. The public doubts the industry's commitment to protect health and safety. People have a sense of "dread," feeling that contact with chemical manufacturing facilities can have serious long-term health consequences.

Surveyed on matters of their knowledge about the environment, 56 percent of the residents disagreed with the statement that the chemical industry causes more air pollution than personal automobiles in Harris County. And 40 percent disagreed that more hazardous wastes enter Galveston Bay in stormwater runoff from neighborhoods than from chemical industry wastewater discharges, while another 20 percent indicated that they did not know whether these statistics on runoffs were accurate or not. Slightly more than 50 percent of the respondents disagreed with the statement that they were more likely to be harmed by chemicals used around their houses than by chemicals released by local chemical plants. Residents were evenly split (50-50) on whether they believed that the chemical industry has done more to clean up air pollution than all the households of Harris County. Slightly over half of the respondents (53 percent) believed that their neighbors work harder to prevent pollution than the average chemical plant in Harris County.

--Robert L. Heath, Ph.D., Professor,
School of Communication, HFAC, UH



People who live further from an industry are more uncertain about its long-term toxic effects, whereas people who live closer to the industry voice more support for the facilities.

Management and Monitoring

EIH • 15

UH/UHCL

Historical Analysis of Precipitation in the Tropics from Oxygen Isotopic Analysis of "Soda Straw" Cave Deposits

Climate changes associated with the El Niño may be determined from models based on the history of rainfall over the last 100 years. Oxygen isotopic analysis tells us that oxygen isotope ratios decrease during seasons and years when rainfall is high. Sample "soda straws" found in caves provide a proxy record of past rainfall.

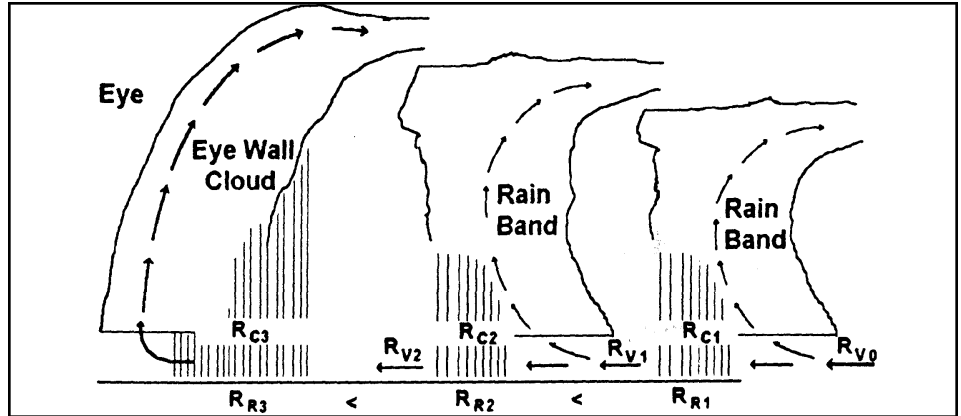

Simple isotope model for a mean hurricane.

THE DEVELOPMENT OF A NEW TOOL TO study climate changes associated with the El Niño has become an absorbing task. The approach of UH geophysicists is novel in that short term climate changes are the focus of design development. The method being followed involves oxygen isotopic analysis of "soda straw" cave deposits utilizing "soda straws" formed over the course of the last few hundred years. This information is useful in calibrating computer global climate models that enable a better understanding of global climate changes.

A climate signal has been shown to exist in the oxygen isotopic composition of rainfall in tropical regions. Our hypothesis is that this signal is transferred to the "soda straws" as they grow over a period of time. The observed relationship in rainfall is that oxygen isotope ratios decrease during seasons and years when rainfall is high. Thus "soda straws" may provide a proxy record of past rainfall. Because low rainfall in the western Pacific ocean is associated with the El Niño, low oxygen isotope values in "soda straws" probably indicate El Niño events. Abundant caves are present in Guam for the collection of samples. In the eastern Pacific and possibly Yucatan Mexico, where abundant caves exist, high rainfall and thereby low oxygen isotope ratios are associated with El Niño events.

The most important first step in current research was to discover whether the climate signal in rainfall is transferred to drip waters in the cave and then, in turn, to "soda straw" cave deposits. Therefore, a field trip undertaken this summer collected rainfall samples, cave drip waters and actively forming "soda straws."

Isotopic analysis is currently under way to

determine if the climate signal is indeed transferred to the "soda straws." If so, we plan to write a proposal to the National Science Foundation to continue these studies. An ARP proposal submitted through EIH to the Texas Higher Educational Board has already been submitted.

Grants

"Biosphere changes in southeast Texas from the carbon isotope study of river waters," Houston Coastal Center, 1995, \$1000.

Publications and Presentations

Lawrence, J. R. and S. D. Gedzelman. "Extraordinary stable isotope ratios of hurricanes," *Nature*. Submitted 1995.

Lawrence, J. R. and S. D. Gedzelman. "The basis for the amount effect in the stable isotopes of water," AGU Chapman Conf. on Water Vapor in the Atmosphere, Jekyll Is., GA., Oct. 25, 1995.

Lawrence, J. R., A. Bosch, and S. D. Gedzelman. "Very low stable isotope ratios in tropical storms and hurricanes," The V. M. Goldschmidt Conference, University Park, PA, May 24-26, 1995.

Lawrence, J. R., A. Bosch, S. D. Gedzelman. "Tropical Cyclones Produce Precipitation with Very Low Stable Isotope Ratios," Amer. Geophys. Un. Spring Meeting, Baltimore, MD, May 30-June 2, 1995.

Lawrence, J. R. "Precipitation from Tropical Cyclones as a Watershed Tracer," Amer. Water Resources Association 31st Annual National/International Conference, Houston, TX, Nov. 6-8, 1995.

--James R. Lawrence, Ph.D., Associate Professor, and Kathy Schwehr, graduate student, Department of Geosciences, UH

Management and Monitoring

16 • EIH

UHCL/UH

The Use of Stable RNAs in Environmental Monitoring

CONSIDERABLE INTEREST EXISTS IN THE use of genetically-engineered microorganisms in the environment. Such organisms offer considerable promise in a wide range of applications, including enhanced waste degradation, improved plant frost resistance, and biological pest control. It is imperative that risks associated with these processes be assessed before they are extensively used in the field. Furthermore, even if they are established to be safe, it will be essential to monitor their actual success in their intended application and their effect on the environment.

Most of any released organisms will either be introduced directly into the soil or eventually reach the soil by environmental transport. Dispersal over considerable distances is possible, and reliable monitoring needs to be much more sensitive than either classical plate-count methods or methods based on phenotypic markers, such as antibiotic resistance. It is widely believed that the best approaches to this monitoring problem will be based on DNA detection (Holben *et al.*, 1989). To this end, polymerase chain reaction methodology has been proposed and, in fact, has been shown to be a considerable advance over the earlier methods (Steffian and Atlas, 1988). There remains considerable room for progress.

For applications in the environment, an alternative method is *rRNA* probing (Amann *et al.*, 1990; Leser *et al.*, 1995), which offers six advantages over a straightforward amplification of a unique DNA target:

- (1) *rRNA* provides a naturally amplified signal, being present in as many as 10,000 copies per cell.
- (2) A quantity of *rRNA* reflects levels of recent cell metabolic activity.
- (3) Procedures for extracting *rRNA* are well understood in terms of limitations, *etc.*
- (4) Probe technology offers a large array of formats, including *in situ* hybridization, with numerous possible reporter groups, including fluorescence and luminescence, making the approach amenable to instrumentation,
- (5) extreme sensitivity can be obtained by further amplifying RNA targets with RNA amplification systems.
- (6) Commercial companies have considerable experience with test design, quality assurance, *etc.*, as a result of work with biomedical products. Despite these achievements, the *rRNA* approach has been perceived to be peripheral to the problem of monitoring

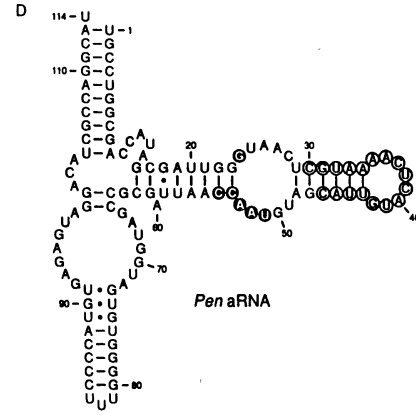
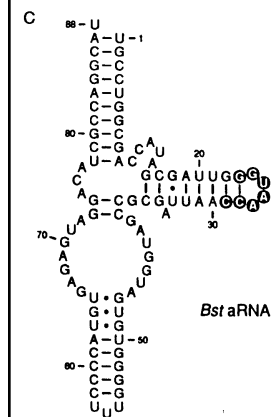
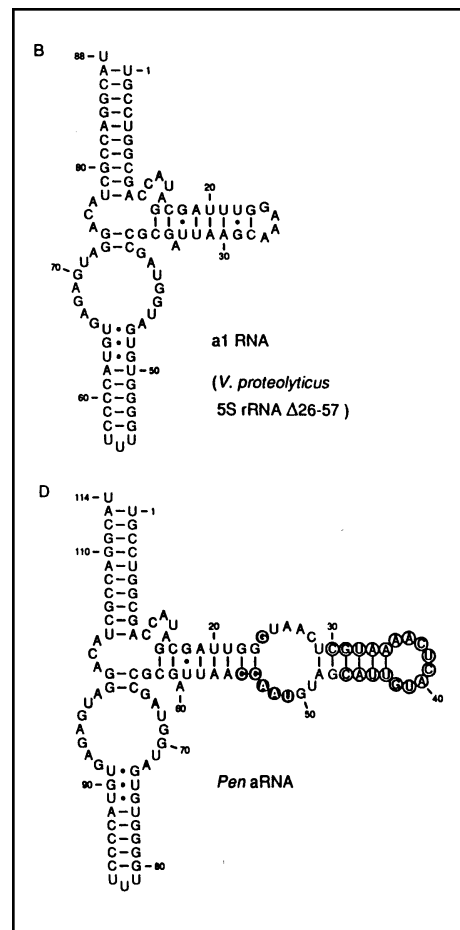
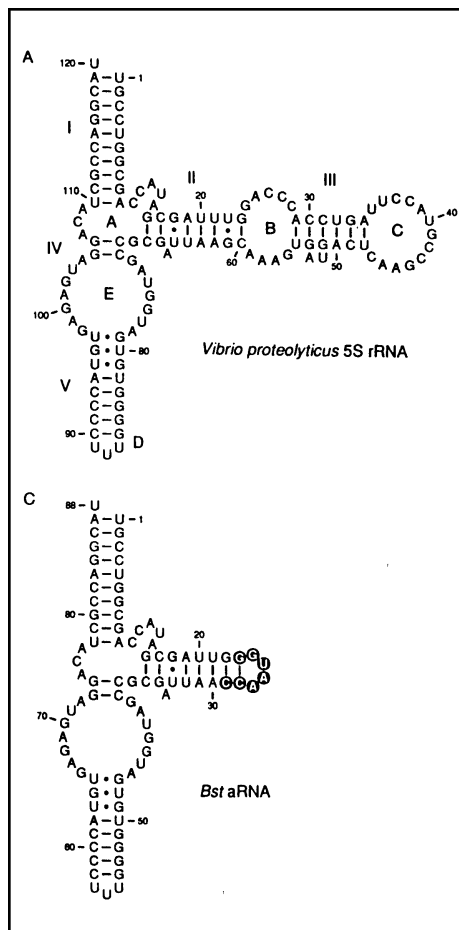

Sequence and possible secondary structure of the *V. proteolyticus* 5S *rRNA* and the expected RNA products of the three constructs described in the text. Wildtype *V. proteolyticus* 5S *rRNA* is shown in (A). Helices are indicated by Roman numerals, and loops are indicated by capital letters in accordance with the nomenclature currently used by the majority of 5S *rRNA* workers. Watson-Crick base-pairs are indicated by dashes and G-U base pairs are indicated by black dots. (B) The 88-base a1 RNA, which was derived by deletion of positions 26-57 in wildtype *V. proteolyticus*, is shown. (C) The 88-base *Bst* aRNA construct is shown. This RNA differs from a1 RNA at positions 22, 25, and 29. As a result, the *Bst* aRNA contains a recognition site for the restriction of endonuclease *Bst*EII. The six bases comprising this recognition site are highlighted with filled circles and white letters. The 114 nucleotide *Pen* aRNA is shown in (D). A 26-nucleotide fragment was inserted into the *Bst*EII site of *Bst* aRNA. The bases comprising the original *Bst*EII site are shown as before. The inset itself extends from position 25 to position 50. The circled bases in the insert indicate the unique 17 nucleotide fragment from *P. purpureum* that can be used as an identifier sequence.

GEMs because it can not distinguish GEMs from naturally occurring organisms.

During the past several years, a stable RNA monitoring system that exploits the advantages of *rRNA* has been under development in our laboratory. The essential idea was established by a prototype system (Hedenstierna *et al.*, 1993) in which a plasmid borne *V. proteolyticus* 5S *rRNA* gene (MacDonell and Colwell, 1985) was incorporated into *E. coli*. In this system the host 5S *rRNA* processing machinery was used to produce a unique stable target RNA that accumulated in quantities similar to

(Continued on page 18.)

Management and Monitoring

EH • 17

UH/UHCL

The Use of Stable RNAs in Environmental Monitoring

(Continued from page 17.)

those seen with normal *rRNA*. The 5S *rRNA* gene was selected because of its small size as well as the fact that it is not known to be a major regulatory element in ribosome biosynthesis and, hence, is not likely to have any unanticipated side effects when present in higher than normal amounts. Subsequently, nine additional cassettes carrying other naturally occurring *Vibrio* sequences were examined. In each case (Lee *et al.*, 1993), RNA accumulation occurred with substantial incorporation into ribosomes with little or no effect on organism growth rate.

This past year, the prototype detection system was brought much closer to practical application by the replacement of the *V. proteolyticus* 5S *rRNA* sequence with a probe target sequence that has a very low probability of being found in the environment. Initially this was accomplished by devising a chimera of an archaeobacterial 5S *rRNA* and *E. coli* 5S *rRNA* (Yang and Fox, 1995). This rather specialized solution has now been superseded by development of a general purpose "5S *rRNA* carrier system" constructed from a 31-base deletion mutant of the *V. proteolyticus* 5S *rRNA*. The deletion mutant was modified by additional point mutagenesis so as to create a *BstEII* cloning site in which replacement DNA could then be inserted. This replacement DNA can thus be used to insert highly unique sequences into the 5S *rRNA* carrier. The expectation is that the normal 5S *rRNA* sequences flanking the detection target will serve to stabilize it. In the initial construct of this type, an insert derived from Napier Grass was successfully stabilized (Pitulle *et al.*, 1995). Work is continuing on cassettes of this type. Results of the past year have spawned two grant proposals.

Management and Monitoring

18 • EIH

UHCL/UH

One of these is focused on the issue of the biochemical basis of 5S *rRNA* stability and the other, the more practical issues of determining just what kinds of sequences can be stabilized by the 5S *rRNA* carrier system.

The cassette work ultimately requires probing of environmental samples. We have, therefore, maintained a continuing interest in procedures for doing this. One format is a simultaneous multiple probing using oligonucleotide probes attached to a silicon wafer. Work on this approach (in conjunction with Genometrix, Inc.) was recently funded. A more standard alternative procedure is the reverse dot blot that was introduced into our laboratory during the past year. This procedure was implemented in the context of distinguishing certain nematodes (Setterquist *et al.*) because (a) appropriate probe targets were already available and (b) the procedure, when used with nematodes, still requires the isolation of target nucleic acid from an environmental sample.

References

- Amann, R. I., L. Krumholz, and D. A. Stahl. "Fluorescent-oligonucleotide probing of whole cells for determinative, phylogenetic, and environmental studies in microbiology." *J. Bacteriol.* 172 (1990): 762-70; T. D. Leser, M. Boye, and N. B. Hendriksen. "Survival and activity of *Pseudomonas* sp. strain B13 (FR1) in a marine microcosm determined by quantitative PCR and an *rRNA*-targeting probe and its effect on the indigenous bacterioplankton," *Appl. Environ. Microbiol.* 61 (1995): 1201-07.
- Holben, W. E., J. K. Jansson, B. K. Chelm, and J. M. Tiedje. "DNA probe method for the detection of specific microorganisms in the soil bacterial community," *Appl. Environ. Microbiol.* 64 (1988): 703-711; Chaudry, G. R., G. A. Toranzos, and A. R. Batti. "Novel method for monitoring genetically-engineered microorganisms in the environment," *Appl. Environ. Microbiol.* 56 (1989): 1301-1304.
- Hedenstierna, O. F., Y-H. Lee, Y. Yang, and G. E. Fox. "A prototype stable RNA identification cassette for monitoring plasmids of genetically-engineered microorganisms," *System. Appl. Microbiol.* 16 (1993): 280-286.
- Lee, Y-H, L. DSouza, and G. E. Fox. "Experimental investigation of an RNA sequence space," *Orig. Life & Evol. Biosphere* 23 (1993): 365-372
- MacDonell, M. T. and Colwell, R. R. "Phylogeny of the Vibrionaceae and recommendation for two new genera, *Listonella* and *Shewanella*," *Syst. Appl. Microbiol.* 6 (1985): 171-82.
- Pitulle, C., K. O. F. Hedenstierna, and G. E. Fox. "Artificial stable RNAs: A novel approach for monitoring genetically engineered microorganisms," *Appl. Environ. Micro.*, 61 (1995). In press.
- Setterquist, R. A., G. K. Smith, R. Jones, and G. E. Fox. "Molecular differentiation of *Pratylenchus penetrans* and *Pratylenchus scribneri* by PCR and DNA hybridization of major sperm protein DNA," *J. Nematology*. Submitted.
- Steffian, R. J. and R. M. Atlas. "DNA amplification

Genetically-engineered microorganisms promise multiple uses.

to enhance detection of genetically-engineered bacteria in environmental samples," *Appl. Environ. Microbiol.* 54 (1988): 2185-91.

Yang, Y. and G. E. Fox. "An archae 5S *rRNA* analog is stably expressed in *Escherichia coli*" *Gene* (1995). In press.

Grants

"An advanced approach to simultaneous monitoring of multiple bacteria in space," NASA (Subcontract with Genometrix, Inc.), June 1995-May 1998, \$240,000.

"Artificial stable RNA's: A novel approach for monitoring genetically-engineered microorganisms," EPA, Aug. 4, 1994-July 31, 1995, \$199,792.

Publications

Pitulle, C., K. O. F. Hedenstierna, and G. E. Fox. "Artificial Stable RNAs: A novel approach for monitoring genetically-engineered microorganisms," *Appl. Environ. Micro.* 61.10 (1995). In press.

Presentations

Fox, G. E. "Molecular evolution workshop," Marine Biological Laboratory, Woods Hole, Mass., August 1994 (invited).

Lee, Y-H., Y. Yang, K. Hedenstierna, C. Pitulle, and G. E. Fox. "Site directed mutagenesis studies in the Helix III/Loop C region of 5S RNA," Abstracts, Frontiers in Translation Conference, May 20-25, Victoria, BC, Canada, (1995), p. 35. (poster presentation).

Pitulle, C., K. O. F. Hedenstierna, L. DSouza, P. D. Braun, and G. E. Fox. "Stable RNA cassettes for monitoring genetically engineered microorganisms," Abstracts, 95th ASM Meeting, N-158 (1995), p. 360.

Setterquist, R. A., T. Oakley, and G. E. Fox. "Cloning and purification of the *Vibrio proteolyticus* 5S RNA binding protein L18," Abstracts, Frontiers in Translation Conference, May 20-25, Victoria, BC, Canada (1995), p. 35.

Siefert, J. L., L. K. Nakamura, R. A. Slepecky, E. R. B. Moore, A. Arnscheidt, P. Jurtschuk, Jr., and G. E. Fox. "Phylogenetic analysis of nine 'Marine' bacillus isolates from the Gulf of Mexico using the 16S *rDNA* gene," Abstracts, 95th ASM Meeting, R31 (1995), p. 484.

--George E. Fox, Ph.D., Professor;
Christian Pitulle, Ph.D., Post-Doctoral
Fellow; Robert Setterquist, and Janet
Siefert, Department of Biophysical and
Biochemical Sciences, UH

Bioluminescent Reporters for Detection of Mutagenic and Carcinogenic Environmental Contaminants

WE HAVE DEVELOPED A SIMPLE, RAPID and sensitive bacterial method for measuring mutagenicity (DNA-damaging activity) in process streams and waste site samples. Mutagenicity correlates strongly with carcinogenicity to humans, and mutagenic wastes require careful detoxification. A rapid assay for mutagenicity would be useful in risk assessment for site characterization and would help minimize chemical waste production by allowing tighter control of processes to minimize production of carcinogenic wastes and by greatly reducing the volume of contaminated materials created, ironically, by testing itself.

The assay is based on measurement of light produced by the enzyme luciferase. Light emission can be easily detected with remarkable sensitivity (detection limit $\sim 10^{-15}$ more, or roughly 40 active *E. coli* cells) in samples of less than one mL. This activity can be used in mutagen detection in two ways. First, as in the well-known Ames test, the assay can use bacterial cells lacking a specific function because of previous, deliberate DNA mutations. Mutagenic activity can be detected because random DNA alterations occasionally reverse the inactivating lesion, leading to restored function with measurable frequency. Unlike the Ames test, which requires the counting of bacterial colonies on large numbers of Petri plates, the luciferase assay uses solution-phase detection of light resulting from random repair of ultradark luciferase mutants developed at the University of Houston by the research group headed by Shia-Chun Tu, professor of biochemistry, and our own group.

A second assay format uses cells harboring active luciferase genes in a format which is induced in response to DNA damage. The second assay lacks the advantage of mutagen typing by use of strains harboring different luciferase mutants, but gives a very rapid rise to mutagen exposure.

This study supported the research and studies of Karine I. Maillard, doctoral student in biochemistry.

Grant

"Bioluminescence Reporters for Hazardous Substances," pre-proposal proposal submitted to the Gulf Coast Hazardous Substance Research Center, Fall 1995.

Publication

Willson, R. "Luciferase-based assays of environmental mutagens," *Environmental Science and Technology*. In press.

--Richard Willson, Ph.D.,
Associate Professor,
Chemical Engineering, UH



Dr. Richard Willson stands at an industrial fermenter utilized in experiments requiring large quantities of recombinant organisms.

Management and Monitoring

EIH • 19

UH/UHCL

EVAL95: A Computer Program for Evaluating Environmental Policy



Assume that a species of fish is considered to be in danger of overfishing. A regulatory agency must adopt a strategy for reducing the fishing pressure and restricting the yield.

THE COMPUTER PROGRAM EVAL95 IS being developed to help in the evaluation of environmental policy choices. EVAL95 is an executable program compiled in C++ language. It contains data definition and data extraction tools suitable for accessing a variety of data sources as well as data analysis and data display tools which allow selective tabular and graphical display. Data analysis tools include linear regression, quadratic regression, and other transformation functions. EVAL95 contains routines for logging data items and taking first differences. These routines permit marginal data analysis, a useful procedure for economic analysis and other forms of policy evaluation.

An Example: To illustrate the application of EVAL95, assume that a species of fish is considered to be in danger of overfishing and policy options are being considered by the regulatory agency. Hypothetical data on the estimated population size, the annual catch, the costs of fishing, and the revenue derived from the catch were entered into EVAL95. The data showed a declining trend in the estimated population size. EVAL95 derived the limit to the rate of consumption which must be maintained to ensure a sustainable fishery. Given the hypothetical data, the ANALYZE feature of EVAL95 determined that the population of adult fish could increase (recover) at a rate of 13 percent per year. Thus, any fishing pressure exceeding 13 percent per year would lead to a decline in the resource.

The next task would be to determine the optimal policy for regulating the fishery. Several options are available for reducing the fishing pressure and restricting the yield.

1. Placing restrictions on the time in which fishing is permitted.
2. Placing restrictions on the type of equipment used so as to shift the pressure off a portion of the adult population.
3. Limiting the yield of each license holder to a fixed amount.
4. Lowering the yield by allocating a percentage of the current catch to each license holder.
5. Imposing a larger fixed fee on each license holder to encourage the marginally profitable to catch other species.
6. Imposing a variable tax on the licensee's catch to reduce the profitability of fishers exploiting large quantities of the resource.
7. Issuing a fixed number of transferable (marketable) permits for catch to participants based on previous share of catch.

In this example, my assessment based on analyses by EVAL95 and knowledge of similar economic and environmental issues would lead to a preference for option 7. Options 1 and 2 are traditional and have failed numerous times to create a sustainable fishery. They do not lead to a solution under this analysis. Options 3 to 5 would encounter monitoring problems and would not be sufficient to solve the problem according to EVAL95. Option 6 has potential for a solution, but the management of the system would be difficult. The seventh alternative yields a more robust solution for achieving sustainable resource exploitation.

--Vance A. Etnyre, Ph.D., Associate Professor,
Department of Economics, Finance, Marketing,
and Decision Sciences, UHCL

Dr. Tom Duening, assistant dean of Business Administration, creator of environmental modules in business, discusses modes of entrepreneurship with his class. ➤



Management and Monitoring

20 • EIH

UHCL/UH

Faculty Workshops To Develop Environmental Modules for Business

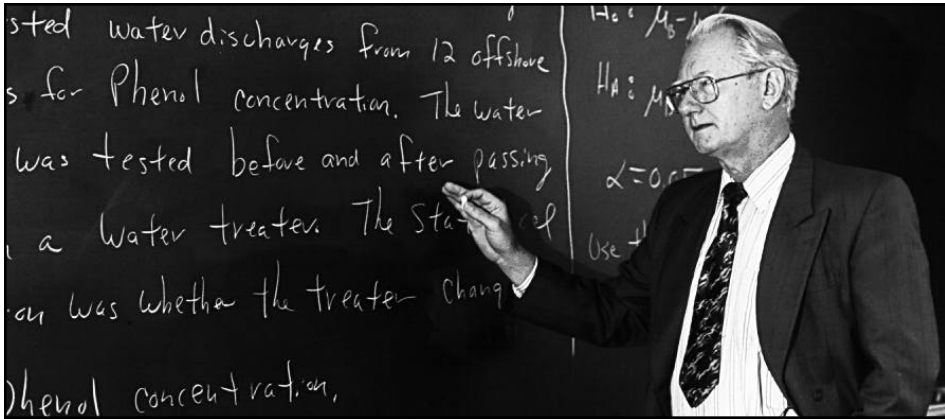

Dr. Gordon Otto, associate professor of Decision and Information Sciences, designed a business course on "environmental data analysis."

A KICK-OFF WORKSHOP FOR THE PROJECT on the development of environmental modules for business courses was held on June 24, 1994. Two months later, on August 24, the first follow-up workshop involved those UHCL faculty members who were serving as specialists on subject matter and the process. Their task was to analyze and comment on the strengths and weaknesses of modules proposed by fellow faculty members from each of the campuses of the University of Houston System.

Modules had been designed at the University of Houston by Devaun Kite, Ph.D., assistant professor of Accountancy and Taxation; Tom Duening, Ph.D., visiting assistant professor and assistant dean, College of Business Administration; Gordon Otto, Ph.D., associate professor of Decision and Information Sciences; Mary Zimmer, visiting assistant professor of Marketing, and Cynthia Jackson, Ph.D., assistant professor of Accountancy and Taxation; at UH Clear Lake, by Edward Waller, Ph.D., assistant professor, Finance; at UH Downtown, by Etta Jones, Ph.D., assistant professor of Business Management and Administrative Services (Bmas); Carl Ruthstrom, Ph.D., associate professor, Bmas; Akbar Marvasti, Ph.D., associate professor of Finance, Accounting, and Computer Information Systems (FACIS); and Margaret Shelton, Ph.D., associate professor, FACIS; and, at UH Victoria, by Amado Esteban, Ph.D., Business.

A second follow-up workshop was held on January 13, 1995, to review six modules developed during the Fall Semester 1994 :

- "Environmental Considerations in Cost

Accounting" [Kite], (Management Accounting 3337).

- "Infusion of Environmental Awareness into Administrative Services Management" [Jones], (Administrative Office Mgt.).
- "Environmental Responsibility of Business" [Duening], (Management 3333).
- "Green Marketing Strategies and Green Consumers: An Environmental Module for Buyer Behavior" [Zimmer], (Marketing 4362).
- "Drivers' Willingness to Pay for Smog Control Systems" [Marvasti], (Environmental and Natural Resources Economics).
- "Environmental Data Analysis Module" [Otto], (Elementary Statistics).

UHCL faculty assessed the strengths and weaknesses of the modules and made suggestions for improvement.

Reviewers approved a module design completed during the Spring Semester 1995:

- "Risk, Cost of Capital, and Valuation: An Environmental Incident Module" [Waller], (Managerial Finance).

A marketing module was completed during the Fall Semester 1994:

- "Environmental Module for Use in Principles of Marketing" [Johnson]

Faculty delivered a presentation on the project on February 16 as part of the EIH Brown Bag Lecture Series at the campus of the University of Houston Clear Lake.

**--Peter Bowman, Ph.D., Director,
Center for Conflict Analysis and
Management; Lecturer, Administrative
Sciences, UHCL**

Environmental business offers end-of-the-century classes for industrial and business personnel confronting in-house issues on the cost & implementation of environmental standards:

- Environmental Considerations in Cost Accounting
- Environmental Awareness in Administrative Services Management
- Environmental Responsibility
- Smog Control Systems
- Data Analysis Modules
- Risk, Cost of Capital, & Valuation
- Principles of Marketing

Environment & the Classroom

EIH • 21

UH/UHCL



Project Environmental Awareness: A Curriculum Plan for Primary Grades

Environmental Education—

- Freshwater Inflow
- Water Education
- Wildscapes



Urban architecture sculptured in the Cullen Family Plaza on the UH campus simulates rugged terrain and sublime mountain lakes.

FEW EARLY CHILDHOOD TEACHERS RECEIVE any type of environmental education, but there is a need to instill environmental awareness in young children. Teachers need to enhance their scientific background and develop strategies for teaching young children about the environment. Most early childhood teachers have few resources to guide them in the use of their own natural surroundings to meet instructional goals mandated by the state.

Four first-grade teachers in the Clear Creek School District participated in this environmental project. They studied available materials and collaborated to produce an environmental curriculum for early primary grades with emphasis on the students' immediate environment: their homes, their backyards, their neighborhood, and their schoolyard. The project included visits to schoolyard conservation projects and the study of their use in the curriculum as well as interviews with community resource people for environmental education. The effort also involved training faculty colleagues of the elementary school teachers in the application of curricular materials that were developed and the use of resources that had been identified.

A curriculum guide developed for first grade teachers outlined strategies for integrating environmental study across the curriculum. By the end of the project, the two schools involved had begun planning the creation of schoolyard conservation projects to support environmental studies.

--Carolyn Black, Ph.D., Assistant Professor, Early Childhood Education, and Margaret Hill, Ph.D., Assistant Professor, Reading/Language Arts, UHCL

THE EPA GULF OF MEXICO PROGRAM funded EIH to develop a multimedia curriculum on the importance of freshwater inflow to the estuaries around the Gulf Coast. EIH has produced and will be distributing an electronic catalog of available educational materials on the scientific understanding of the impact of natural and human-induced variation in freshwater inflow on the biological, chemical, and physical characteristics of coastal estuaries.

In the summer of 1995, EIH became a regional coordinator for a new national curriculum in environmental education, Project WET (Water Education for Teachers) in cooperation with the Caddo Lake Institute, which is the state coordinator for the dissemination of this curriculum to K-12 teachers in the Houston region.

EIH is coordinating a network of schools, agencies, and organizations working together to support the creation and use of schoolyard conservation sites, termed "wildscapes." More than 20 schools in the Houston region currently have functioning wildscapes. Characteristics of the sites are described in a database developed by Texas Parks and Wildlife Urban Biologists and EIH staff. The database contains a list of recommended curricula and resource books for utilizing wildscape sites in the teaching of environmental studies across the curriculum.

EIH Education Coordinator, Lynn Spachuk, delivered presentations on conservation site usage at the Third Gulf of Mexico Symposium in Corpus Christi in March and at the meeting of the Western Regional Environmental Education Council in St. Louis in July. In February, she was featured on the state-wide educational TV program "Eye on Earth," in an interview on environmental education and conservation sites.

--Lynn Spachuk, EIH Education Coordinator, and Robert Jones, Ed.D., Professor of Education, UHCL

Environment & the Classroom

22 • EIH

UHCL/UH



Principal Investigators

John A. McDonald
Director, AGL

Name	Rank	Affiliation	Phone	Mail Code
Leonard Bachman	Asst. Prof.	Architecture, UH	743-2372	77204-4431
Michael Benedik	Assoc. Prof.	Biophysical and Biochemical Sciences, UH	743-8377	77204-5934
Carolyn Black	Asst. Prof.	Early Childhood Education, UHCL	283-3573	77058-1321
Peter Bowman	Dir.	Center for Conflict Analysis, UHCL	283-3125	77058-2117
Guy N. Cameron	Prof.	Biology, UH	743-2674	77204-5513
Regina Capuano	Asst. Prof.	Geosciences, UH	743-3426	77204-5503
Dan Ebrom	Res. Asst. Prof.	Allied Geophysical Labs, UH	743-9144	77204-4231
Vance A. Etnyre	Assoc. Prof.	Economics, Fin, Mktg, and Decision Sci, UHCL	283-3205	77058-3121
Joan Few	Adj. Asst. Prof.	Archeology Lab, UHCL	283-3318	77058-1098
George E. Fox	Prof.	Biophysical and Biochemical Sciences, UH	743-8363	77204-5934
Theron D. Garcia	Assoc. Prof.	Environmental Sciences, UHCL	283-3776	77058-3532
Jean-Marc Gauthier	Visit. Lecturer	Architecture, UH	523-1368	77006
William Hartman	Visit. Lecturer	Architecture, UH	743-2400	77204-4431
Margaret H. Hill	Asst. Prof.	Reading/Language Arts, UHCL	283-3533	77058-1119
Robert L. Heath	Prof.	Communications, UH	743-2882	77204-3783
David Hoffman	Prof.	Chemistry, UH	743-3255	77204-5641
James R. Lawrence	Assoc. Prof.	Geosciences	743-3410	77204-5503
Lewis T. May	Lecturer	Architecture, UH	743-2400	77204-4431
John A. McDonald	Prof.	Geosciences, AGL, UH	743-9150	77204-4231
Cumaraswamy Vipulanandan	Assoc. Prof.	Civil & Environmental Engineering, UH	743-4278	77204-4791
John C. Watson	Vis. Asst. Prof.	Electrical/Electronic Technology, UH	743-4077	77204-4083
Richard Willson	Assoc. Prof.	Chemical Engineering, UH	743-4308	77204-4792
David Zeh	Asst. Prof.	Biology, UH	743-2690	77204-5513

University of Houston, Houston, TX 77204-[+ Mail Code]

University of Houston Clear Lake, 2700 Bay Area Blvd., Houston, TX 77058-[+ Mail Code]

The Environmental Institute of Houston on the World-Wide Web: <http://www.eih.uh.edu>

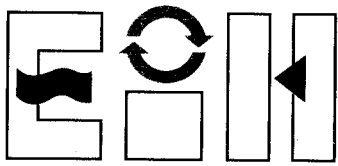

Environmental Institute of Houston

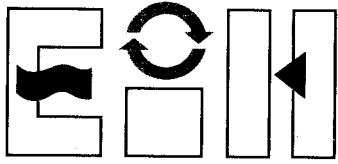

Environmental Institute of Houston

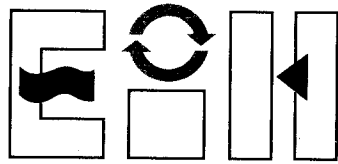

Environmental Institute of Houston

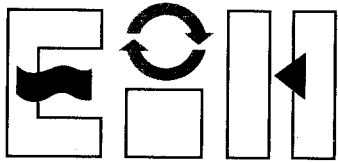

Environmental Institute of Houston

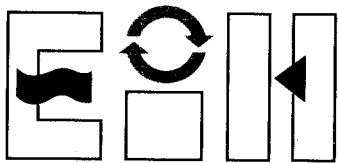

Environmental Institute of Houston

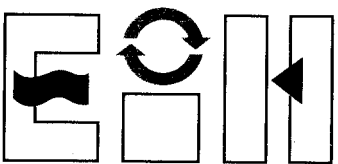

Environmental Institute of Houston

University of Houston Clear Lake
University of Houston